

OLTRE



FINITURE MATERICHE TEXTURED FINISHES

Rigorosa nella sua linearità ma ricca nella sua essenza Oltre presenta, finiture particolari ed accessori che la rendono assolutamente unica nel suo genere. I colori ed i materiali sono tanti e studiati per essere abbinati elegantemente insieme, raffinati e pregiati come le ante realizzate con malta stesa a mano, con effetto cemento, oppure in legno impiallacciato dalla forte tattilità. Caratterizzata dalla meticolosa cura del dettaglio e da un'ampia modularità, Oltre diventa protagonista anche nello spazio living e dining con esclusive soluzioni arredative di design.

Oltre offers rigorous lines and a rich essence, with many different finishes, details and accessories that make it unique in its genre. There are many colours and materials available, all designed to blend together elegantly to create a refined and exclusive look, such as doors with cement-effect hand-applied mortar and those with highly tactile wood veneer. Characterised by a meticulous attention to detail and a high level of modularity, Oltre is also a star of the living room and dining area, offering exclusive designer furnishing solutions.

L'ANTA QUADRATA SI ABBINA ALLA GOLA AD "ELLE" PER CREARE LA COLLEZIONE NECK. UN' ANTA PRESENTATA IN UN' AMPIA GAMMA DI COLORI E FINITURE CHE POSSONO PERSONALIZZARE LA GOLA.

THE SQUARE DOOR MATCHES WITH THE "L" FINGER RAIL OPENING TO CREATE THE NECK COLLECTION.

THE DOOR IS PRESENTED ON A WIDE RANGE OF COLOURS AND FINISHES THAT CAN CUSTOMIZE THE FINGER RAIL OPENING.

OLTRE

Neck

ANTA QUADRATA
CON MANIGLIA A GOLA
SQUARE DOOR WITH FINGER
RAIL OPENING



L'ERGONOMIA DELLA FORMA DELL'ANTA CARATTERIZZA LA COLLEZIONE LUX. L'ANTA CON PROFILO INCLINATO IN CORRISPONDENZA DELLA GOLA, OFFRE UNA PRESA ED UN'APERTURA MIGLIORI. L'ANTA PUO' ESSERE DOTATA DI UN PROFILO DI PROTEZIONE COORDINATO ALLE FINITURE E COLORI DELLA GOLA.

THE LUX COLLECTION IS CHARACTERIZED BY THE DOORS ERGONOMIC FORM. THE DOOR WITH AN INCLINED PROFILE NEAR THE FINGER RAIL OPENING SYSTEM, OFFERS THE BEST POSSIBLE GRIP AND OPENING. THE DOOR MAY BE EQUIPPED WITH A PROTECTION PROFILE COORDINATED WITH THE FINGER RAIL OPENING SYSTEM FINISHES AND COLOURS.

OLTRE

LUX

ANTA INCLINATA
CON MANIGLIA A GOLA
INCLINED DOOR WITH FINGER
RAIL OPENING



APERTURA CON GOLLA OPENING BY FINGER RAIL

Neck

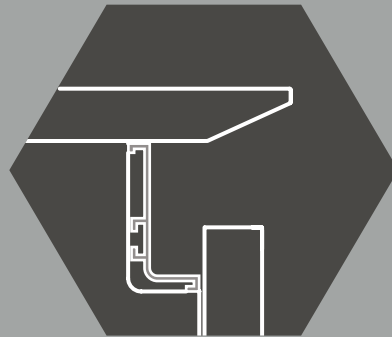

GOLA TIPO "ELLE"
"ELLE" TYPE FINGER RAIL

ANTA SQUADRATA
DOOR SQUARED

LUX

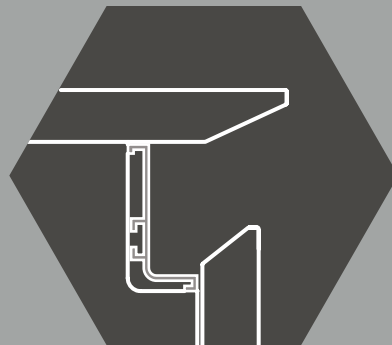
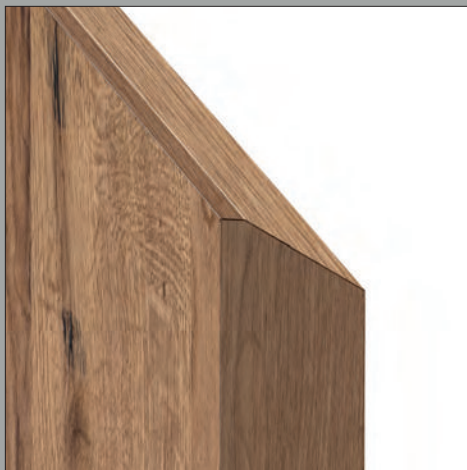

GOLA TIPO "ELLE"
"ELLE" TYPE FINGER RAIL

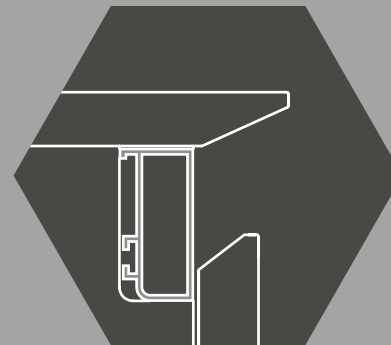

GOLA PIATTA
FLAT FINGER RAIL

ANTA INCLINATA
SENZA PROFILO
INCLINED EDGE DOOR
WITHOUT PROFILE

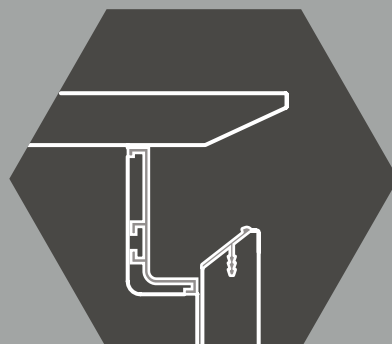
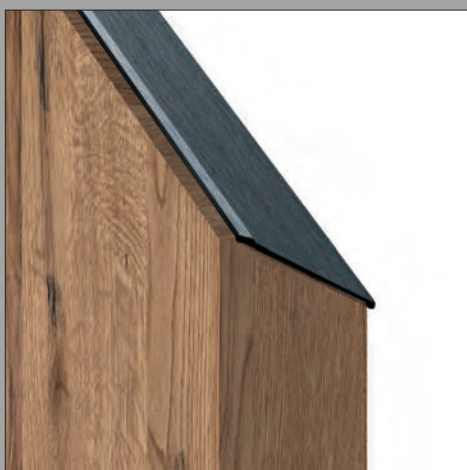

GOLA TIPO "ELLE"
"ELLE" TYPE FINGER RAIL

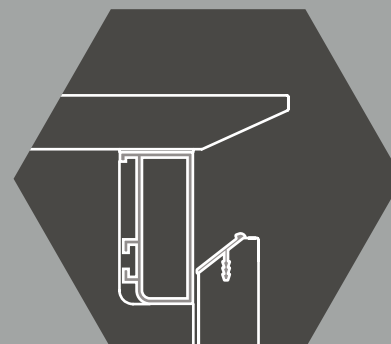

GOLA PIATTA
FLAT FINGER RAIL

ANTA INCLINATA
CON PROFILO
ALLUMINIO
(OPZ. P I + COD. COLORE)
INCLINED EDGE DOOR
WITH ALUMINIUM PROFILE

NECK-LUX



FINITURE GOLE E PROFILO

FINITURE GOLE E PROFILO SPAZZOLATI FINGER RAILS AND PROFILE BRUSHED FINISHES



FINITURE GOLE E PROFILO VERNICIATI A POLVERE OPACHI MATT FINGER RAILS AND PROFILE POWDER COATED FINISHES

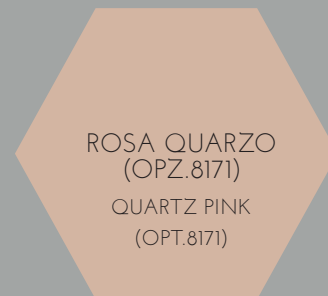
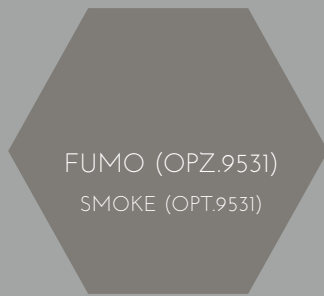
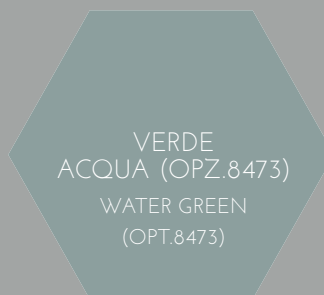
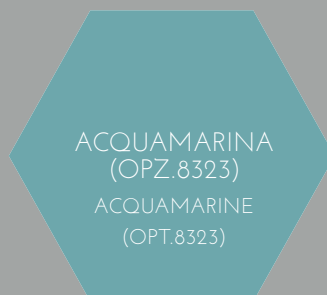

SP. 22 MM

OLTRE Neck
Lux

N.B.: i prezzi sono espressi all'unità di euro (iva esclusa)

CARATTERISTICHE TECNICHE

ANTE E FRONTALI CASSETTI

anta sp.22 mm impiallacciata **rovere vintage con nodi e stuccature venatura verticale finitura materica** nei colori: rovere bianco invecchiato (opz.5380), rovere juta invecchiato (opz.5381), rovere corteccia invecchiato (opz.5382), rovere mielato invecchiato (opz.5383), rovere antracite invecchiato (opz.5384), rovere argilla invecchiato (opz.5385), rovere moro invecchiato (opz.5386), rovere naturale invecchiato parquettato (opz.5387), rovere madera termocotto con finto tarlo (opz.5388)

anta sp.22 mm impiallacciata **rovere effetto pettinato venatura verticale finitura materica** nei colori: rovere gesso (opz.5395), rovere sabbia (opz.5396), rovere lavagna (opz.5397), rovere titanio (opz.5398)

VERSIONE **NECK**

anta squadrata, per gola ad "ELLE"

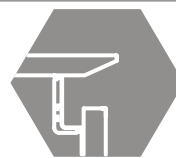

VERSIONE **LUX** PROFILI E GOLE

di serie: anta profilo inclinata per gola ad "ELLE"
a richiesta: anta profilo inclinata per gola piatta

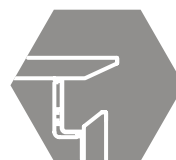

a richiesta: anta profilo alluminio inclinata per gola ad "ELLE"
anta profilo alluminio inclinata per gola piatta

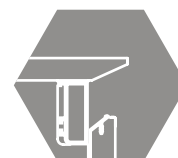

STRUTTURE

ANTE: rovere argilla invecchiato, rovere gesso

di serie : nobilitato bianco (opz.001) schiena e ripiano bianco (opz.001)

ANTE: rovere bianco invecchiato, rovere juta invecchiato, rovere sabbia, rovere titanio

di serie : nobilitato visone (opz.948M) schiena e ripiano visone (opz.948M)

ANTE: rovere antracite invecchiato, rovere lavagna

di serie : nobilitato lavagna (opz.9620) schiena e ripiano lavagna (opz.9620)

ANTE: rovere corteccia invecchiato, rovere mielato invecchiato, rovere moro invecchiato, rovere naturale parquettato, rovere madera termocotto

di serie : nobilitato fango (opz.8860) schiena e ripiano fango (opz.8860)

a richiesta : nobilitato perla d'oriente (opz.940) schiena e ripiano bianco (opz.001)
nobilitato devalè finitura grafis (opz.796) schiena e ripiano bianco (opz.001)



MENSOLE

di serie: altezza cm 3,8 in laminato come strutture: bianco (opz.001), perla d'oriente (opz.940), devalè grafis (opz.796), visone (opz.948M), lavagna (opz.9620), fango (opz.8860)

a richiesta: altezza cm 3,8 impiallacciata finiture come ante

ZOCCOLI

di serie: zoccolo H 6 in alluminio finitura titanio ossidato (opz.414)

a richiesta: zoccolo H 6 in alluminio finiture urban ossidato (opz.NU), brill (opz.412)

zoccolo H 6 in alluminio verniciato a polvere finitura opaca nei colori: nero (opz.7892),

giallo ambra (opz.8225), salvia (opz.8443), rosso toscano (opz.8157), grigio nebbia (opz.9551),

bianco assoluto (opz.740S), acquamarina (opz.8323), verde acqua (opz.8473), verde positano (opz.8471),

castoro (opz.8907), verde lichene (opz.8463), grigio bromo (opz.9533), fumo (opz.9531),

bianco caldo (opz.7401), rosa quarzo (opz.8171), blu cadetto (opz.8373),



TH. 22 MM

OLTRE **N**eck
LUX

Note: the prices are expressed in units of Euro (vat not included)

TECHNICAL FEATURES

DOORS AND DRAWER FRONTS

22 mm th. veneered door **vintage oak with knots and filler vertical grain textured finish** in the following colours: white aged oak (opt.5380), jute aged oak (opt.5381), bark aged oak (opt.5382), honey aged oak (opt.5383), anthracite aged oak (opt.5384), clay aged oak (opt.5385), dark aged oak (opt.5386), parquet-effect natural aged oak (opt.5387) heat treated madera oak with worm-eaten effect (opt.5388)

22 mm th. veneered door **combed-effect oak vertical grain textured finish** in the following colours: chalk oak (opt.5395), sand oak (opt.5396), slate grey oak (opt.5397), titanium oak (opt.5398)

NECK VERSION

square edge door, for "L-SHAPED" finger rail

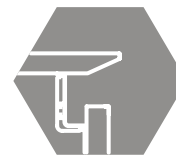

PROFILES AND FINGER RAILS LUX VERSION

standard: inclined edge door, for "L-SHAPED" finger rail
on request: inclined edge door, for flat finger rail

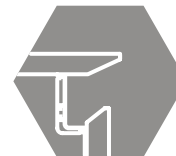

on request: aluminium inclined edge door, for "L-SHAPED" finger rail
aluminium inclined edge door, for flat finger rail

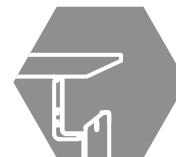

STRUCTURES

DOORS: clay aged oak, chalk oak

standard: melamine-coated white (opt.001), white back panel and shelf (opt.001)

DOORS: white aged oak, jute aged oak, sand oak, titanium oak

standard: melamine-coated mink (opt.948M), mink back panel and shelf (opt.948M)

DOORS: anthracite aged oak, slate grey oak

standard: melamine-coated slate grey (opt.9620), slate grey back panel and shelf (opt.9620)

DOORS: bark aged oak, honey aged oak, dark aged oak, parquet-effect natural aged oak, heat treated madera oak

standard: melamine-coated mud (opt.8860), mud back panel and shelf (opt.8860)

on request: melamine-coated oriental pearl (opt.940), white back panel and shelf (opt.001)

melamine-coated devalè with grafis finish (opt.796), white back panel and shelf (opt.001)

SHELVES

standard: height 3.8 cm, in laminate to match structure: white (opt.001), oriental pearl (opt.940), devalè grafis (opt.796), mink (opt.948M), slate grey (opt.9620), mud (opt.8860)

on request: height 3.8 cm, veneered to match doors

PLINTHS

standard: plinth H 6 cm, in aluminium with oxidised titanium (opt.414) finish

on request: plinth H 6 cm in aluminium with oxidised urban (opt.NU), brill (opt.412) finishes

plinth H 6 cm in aluminium with matt powder coating in the following colours: black (opt.7892), amber yellow (opt.8225), sage (opt.8443), tuscan red (opt.8157), mist grey (opt.9551), absolute white (opt.740S), aquamarine (opt.8323), water green (opt.8473), positano green (opt.8471), beaver (opt.8907), lichen green (opt.8463), bromine grey (opt.9533), smoke (opt.9531), warm white (opt.7401), rose quartz (opt.8171), cadet blue (opt.8373),

cod. **G50**_{Neck} **G60**_{Lux} Impiallacciato Veneered

SP. 22 MM TH. 22 MM

anta finitura materica vintage
door with textured vintage finish

OLTRE **Neck**
Lux



rovere bianco invecchiato
(opz.5380)
white aged oak (opt.5380)



rovere juta invecchiato
(opz.5381)
jute aged oak (opt.5381)



rovere corteccia invecchiato
(opz.5382)
bark aged oak (opt.5382)



rovere mielato invecchiato
(opz.5383)
honey aged oak (opt.5383)

Neck



particolare anta squadrata
squared edge door detail



rovere antracite invecchiato
(opz.5384)
anthracite aged oak
(opt.5384)



rovere argilla invecchiato
(opz.5385)
clay aged oak (opt.5385)



rovere moro invecchiato
(opz.5386)
dark aged oak (opt.5386)



rovere naturale invecchiato
parquettato (opz.5387)
parquet-effect natural aged
oak (opt.5387)

Lux



particolare anta inclinata
inclined edge door detail



particolare anta inclinata
con profilo alluminio
inclined edge door with
aluminium profile detail



rovere maderia termocotta
con finto tarlo (opz.5388)
heat treated maderia oak
with worm-eaten effect
(opt.5388)



particolare anta con finto tarlo
door with worm-eaten effect detail

cod. **G50**_{Neck} **G60**_{Lux} Impiallacciato Veneered

SP. 22 MM TH. 22 MM

OLTRE **N**eck
Lux

anta finitura materica effetto pettinato
door with combed-effect textured finish



rovere gesso (opz.5395)
chalk oak (opt.5395)



rovere sabbia (opz.5396)
sand oak (opt.5396)



rovere lavagna (opz.5397)
slate grey oak (opt.5397)



rovere titanio (opz.5398)
titanium oak (opt.5398)

Neck



particolare anta squadrata
squared edge door detail

Lux



particolare anta inclinata
inclined edge door detail



particolare anta inclinata
con profilo alluminio
inclined edge door with
aluminium profile detail



SP. 22 MM

OLTRE Neck
Lux

N.B.: i prezzi sono espressi all'unità di euro (iva esclusa)

CARATTERISTICHE TECNICHE

ANTE E FRONTALI CASSETTI

anta sp.22 mm con pannello in truciolare E1 rivestito lato esterno con fenix spessore 9/10 lato interno in laminato spessore 9/10 in tinta come esterno, bordata in polipropilene con incollaggio laser spessore 10/10; nella versione Lux con presa maniglia il lato inclinato è bordato in polipropilene spessore 10/10 incollaggio poliuretano nei colori: bianco caldo (opz.7446), castoro (opz.8864), nero (opz.7861), grigio bromo (opz.9628), fumo (opz.9629)

VERSIONE NECK

anta squadrata, per gola ad "ELLE"

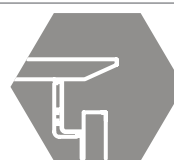

VERSIONE LUX PROFILI E GOLE

di serie: anta profilo inclinata per gola ad "ELLE"
a richiesta: anta profilo inclinata per gola piatta

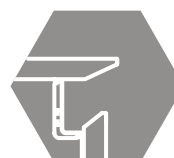

a richiesta: anta profilo alluminio inclinata per gola ad "ELLE"
anta profilo alluminio inclinata per gola piatta

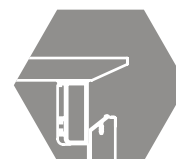
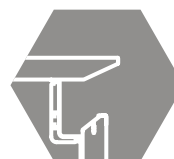

STRUTTURE

ANTA: bianco caldo

di serie : nobilitato bianco (opz.001) schiena e ripiano bianco (opz.001)

ANTA: fumo

di serie : nobilitato visone (opz.948M) schiena e ripiano visone (opz.948M)

ANTE: nero, grigio bromo

di serie : nobilitato lavagna (opz.9620) schiena e ripiano lavagna (opz.9620)

ANTA: castoro

di serie : nobilitato devalè finitura grafis (opz.796) schiena e ripiano bianco (opz.001)

a richiesta : nobilitato perla d'oriente (opz.940) schiena e ripiano bianco (opz.001)
nobilitato fango (opz.8860) schiena e ripiano fango (opz.8860)



MENSOLE

di serie: altezza cm 3,8 in laminato come strutture: bianco (opz.001), perla d'oriente (opz.940), devalè grafis (opz.796), visone (opz.948M), lavagna (opz.9620), fango (opz.8860)

a richiesta: altezza cm 3,8 finiture come ante

ZOCCOLI

di serie: zoccolo H 6 in alluminio finitura titanio ossidato (opz.414)

a richiesta: zoccolo H 6 in alluminio finiture urban ossidato (opz.NU), brill (opz.412)

zoccolo H 6 in alluminio verniciato a polvere finitura opaca nei colori: nero (opz.7892), giallo ambra (opz.8225), salvia (opz.8443), rosso toscano (opz.8157), grigio nebbia (opz.9551), bianco assoluto (opz.740S), acquamarina (opz.8323), verde acqua (opz.8473), verde positano (opz.8471), castoro (opz.8907), verde lichene (opz.8463), grigio bromo (opz.9533), fumo (opz.9531), bianco caldo (opz.7401), rosa quarzo (opz.8171), blu cadetto (opz.8373),



TH. 22 MM

OLTRE **N**eck **L**UX

Note: the prices are expressed in units of Euro (vat not included)

TECHNICAL FEATURES

DOORS AND DRAWER FRONTS

22 mm th. door with E1 chipboard panel with exterior coated in 9/10 thickness Fenix and interior in 9/10 thickness laminate in the same colour as the exterior. Edge in 10/10 thickness polypropylene with laser gluing. The Lux version with handle grip has 10/10 thickness polypropylene edging on the inclined side with polyurethane gluing in the following colours: warm white (opt.7446), beaver (opt.8864), black (opt.7861), bromine grey (opt.9628), smoke (opt.9629)

NECK VERSION

square edge door, for "L-SHAPED" finger rail

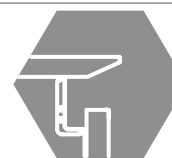

PROFILES AND FINGER RAILS LUX VERSION

standard: inclined edge door, for "L-SHAPED" finger rail
on request: inclined edge door, for flat finger rail

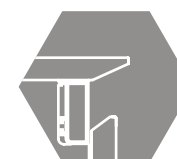
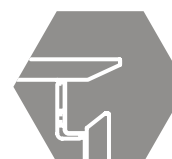

on request: aluminium inclined edge door, for "L-SHAPED" finger rail
aluminium inclined edge door, for flat finger rail

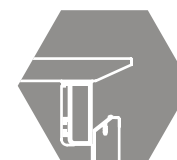
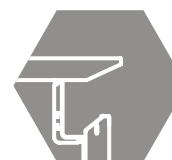

STRUCTURES

DOOR: warm white
standard: melamine-coated white (opt.001), white back panel and shelf (opt.001)
DOOR: smoke
standard: melamine-coated mink (opt.948M), mink back panel and shelf (opt.948M)
DOORS: black, bromine grey
standard: melamine-coated slate grey (opt.9620), slate grey back panel and shelf (opt.9620)
DOOR: beaver
standard: melamine-coated devalè with grafis finish (opt.796), white back panel and shelf (opt.001)

on request: melamine-coated oriental pearl (opt.940), white back panel and shelf (opt.001)
melamine-coated mud (opt.8860), mud back panel and shelf (opt.8860)

SHELVES

standard: height 3.8 cm, in laminate to match structure: white (opt.001) oriental pearl (opt.940) devalè grafis (opt.796), mink (opt.948M), slate grey (opt.9620), mud (opt.8860)

on request: height 3.8 cm, finished to match doors

PLINTHS

standard: plinth H 6 cm, in aluminium with oxidised titanium (opt.414) finish

on request: plinth H 6 cm in aluminium with oxidised urban (opt.NU), brill (opt.412) finishes
plinth H 6 cm in aluminium with matt powder coating in the following colours: black (opt.7892), amber yellow (opt.8225), sage (opt.8443), tuscan red (opt.8157), mist grey (opt.9551), absolute white (opt.740S), aquamarine (opt.8323), water green (opt.8473), positano green (opt.8471), beaver (opt.8907), lichen green (opt.8463), bromine grey (opt.9533), smoke (opt.9531), warm white (opt.7401), rose quartz (opt.8171), cadet blue (opt.8373),

SP. 22 MM TH. 22 MM

OLTRE **N**eck **L**ux

anta finitura fenix

door with fenix finish

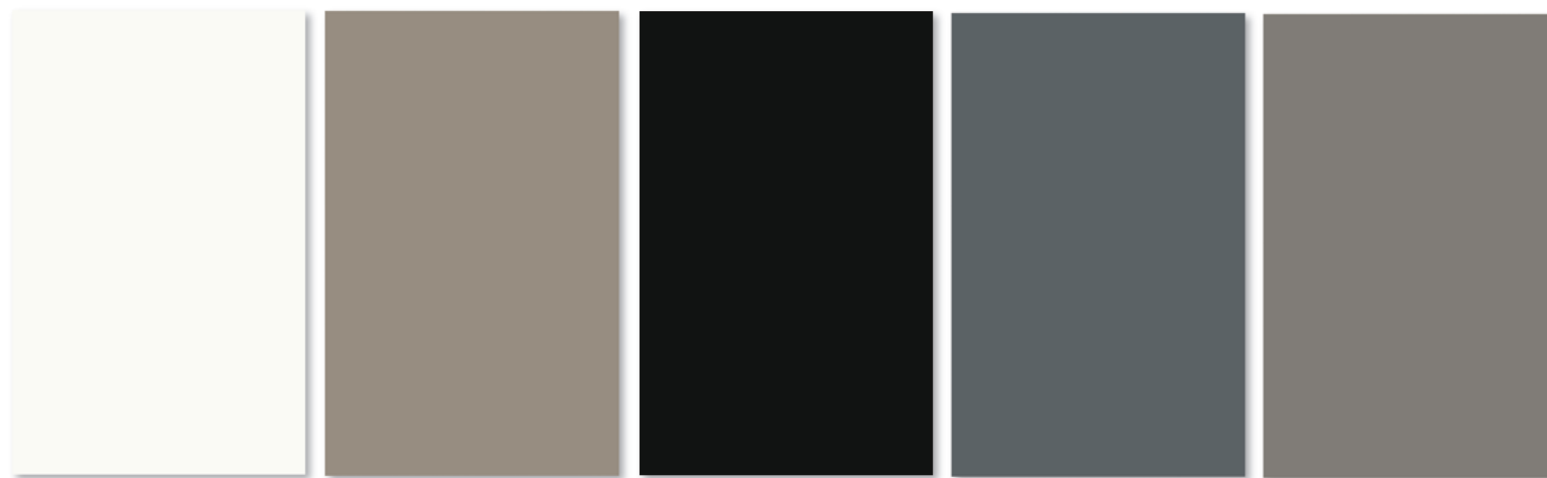

bianco caldo (opz.7446)
warm white (opt.7446)

castoro (opz.8864)
beaver (opt.8864)

nero (opz.7861)
black (opt.7861)

grigio bromo (opz.9628)
bromine grey (opt.9628)

fumo (opz.9629)
smoke (opt.9629)

Informazioni tecniche

FENIX NTM™

È un nuovissimo prodotto per l'interior design sviluppato da Arpa Industriale.

Prodotto grazie a resine di nuova generazione, questo materiale intelligente si contraddistingue per una superficie dalle proprietà straordinarie.

Con una bassa riflessione della luce, la sua superficie è estremamente opaca (valore di riflessione speculare: 1,5 e 60°) e anti impronte digitali.

Grazie all'utilizzo della nanotecnologia, eventuali micrograffi possono essere riparati termicamente ed è inoltre piacevolmente soft touch.

FENIX NTM™ è Made in Italy.

FENIX NTM™ è un materiale innovativo di Arpa Industriale creato per l'interior design prodotto mediante l'applicazione simultanea di calore (circa 150°C) e alta pressione specifica (> 7 MPa) per ottenere un prodotto omogeneo non poroso con densità elevata.

Il suo core è composto da carta impregnata in resina termoindurente mentre la superficie decorativa, ottenuta con l'ausilio di nanotecnologie, è costituita da una carta decorativa trattata con resine di nuova generazione frutto della ricerca di Arpa Industriale.

FENIX NTM™ è un materiale che si distingue per particolari caratteristiche quali: alta resistenza al graffio e al calore, anti impronta, morbidezza al tatto, bassa riflessione della luce, riparabilità termica dei micrograffi, alta attività di abbattimento della carica batterica.

FENIX NTM™ è un marchio registrato da Arpa Industriale.

FENIX NTM™ è placcato su truciolare idrorepellente e il top è bordato sui lati a vista con polipropilene spessore 1 mm in tinta.

Technical information

FENIX NTM™

It is a brand new interior design product developed by Arpa Industriale.

Using the most modern resins, this intelligent material stands out for the extraordinary characteristics of its surface.

The matt surface has an exceptionally low reflectivity (specular reflection index: 1.5 and 60°) and is highly resistant to hand and finger prints.

The material uses nanotechnology to enable micro-scratches to be healed thermally, and it also has a very pleasant soft touch effect.

FENIX NTM™ is Made in Italy.

FENIX NTM™ is an innovative interior design product from Arpa Industriale, made by applying heat (around 150°C) and high pressure (> 7 MPa) to obtain a non-porous very dense material.

Its core is composed of paper impregnated with thermosetting resin, while the surface, which employs nanotechnology processes, is composed of a decorative paper treated with the most recently developed resins from the Arpa Industriale research labs.

FENIX NTM™ stands out for its exceptional resistance to scratching, heat and hand and finger prints, soft touch, low reflectivity, thermal healing of micro-scratches, and effective anti-bacterial action.

FENIX NTM™ is a registered trademark of Arpa Industriale.

FENIX NTM™ is fixed on waterproof fiberboard and the top is trimmed on visible sides with 1 mm polypropylene in matching colour.

Neck

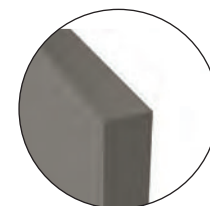

particolare anta squadrata
squared edge door detail

Lux

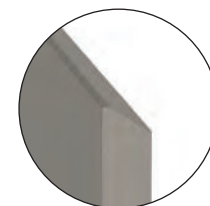

particolare anta inclinata
inclined edge door detail

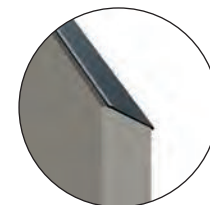

particolare anta inclinata
con profilo alluminio
inclined edge door with
aluminium profile detail

FENIX NTM™



Resistenza ai graffi e all'abrasione
Resistance to scratches and abrasion



Alta attività di abbattimento della carica batterica
Enhanced anti-bacterial properties



Igienico
Hygienic



Idoneo al contatto con gli alimenti
Suitable for contact with food



Facile da pulire
Easy to clean



Antimuffa
Mold-resistant



Antistatico
Antistatic



Idrorepellente
Water proof



Bassa riflessione della luce, superficie estremamente opaca
Low light reflection, extremely matt surface



Anti-impronta
Anti-huella digital



Stabilità dimensionale in presenza di elevata variazione termica
Dimensional stability even at high temperature changes



Resistenza all'urto
Resistance to impact



Stabilità alla luce
Lightfastness



Resistenza al calore secco
Resistance to dry heat



Eccellente intensità e profondità del colore
Excellent intensity and colour depth



Resistenza allo strofinamento
Rub resistance



Elevata resistenza a solventi acidi e ai reagenti di uso domestico
High resistance to acid solvents and household reagents



Autoportante (solo per gli spessori 10 e 12 mm)
Self-supporting (only for 10 and 12 mm)



Riparabilità termica dei micrograffi
Repairability thermal micro-scratches



Morbidezza al tatto
Soft to the touch

FENIX NTM™

RIPARABILITÀ TERMICA DEI MICROGRAFFI
Nanotech matt material for interior design



ISTRUZIONI PER LA MANUTENZIONE.
MAINTENANCE

FERRO DA STIRO.
CLOTHES IRON

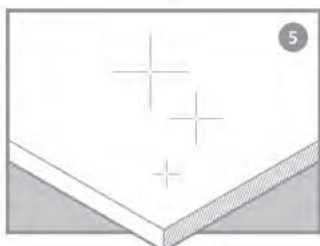
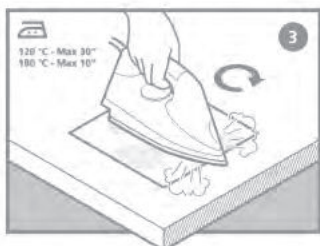
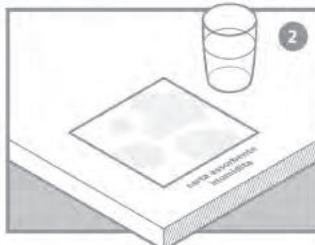
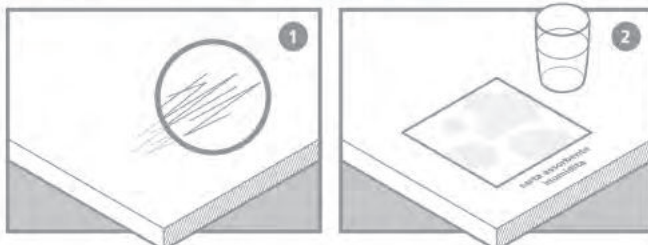

ISTRUZIONI PER LA MANUTENZIONE.
MAINTENANCE

SPUGNA DI SCHIUMA MELAMMINICA.
MELAMINE FOAM SPONGE

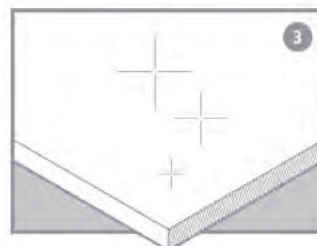
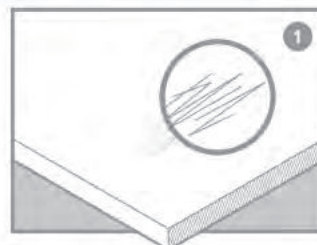

Visiti fenixntm.com
go to fenixntm.com

per scoprire tutte le proprietà
for further details

made in Italy by Arpa Industriale

SP. 22 MM

OLTRE Neck
LUX

N.B.: i prezzi sono espressi all'unità di euro (iva esclusa)

CARATTERISTICHE TECNICHE

ANTE E FRONTALI CASSETTI

anta sp.22 mm composta da un supporto in agglomerato di legno rivestito su due lati con pannelli in HDF classe E1, ricoperto in malta cementizia nei colori: old white (opz.MA11), old grey (opz.MA12), old dark (opz.MA13), old black (opz.MA14)

VERSIONE NECK

anta squadrata, per gola ad "ELLE"



VERSIONE LUX PROFILI E GOLE

di serie: anta profilo inclinata per gola ad "ELLE"
a richiesta: anta profilo inclinata per gola piatta

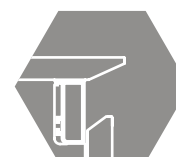

a richiesta: anta profilo alluminio inclinata per gola ad "ELLE"
anta profilo alluminio inclinata per gola piatta

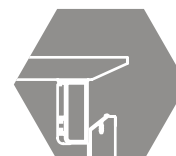
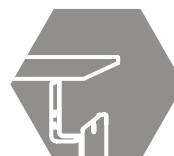

STRUTTURE

ANTA: old white

di serie : nobilitato devalè finitura grafis (opz.796) schiena e ripiano bianco (opz.001)

ANTA: old grey, old black

di serie : nobilitato lavagna (opz.9620) schiena e ripiano lavagna (opz.9620)

ANTA: old dark

di serie : nobilitato fango (opz.8860) schiena e ripiano fango (opz.8860)

a richiesta : nobilitato perla d'oriente (opz.940) schiena e ripiano bianco (opz.001)
nobilitato bianco (opz.001) schiena e ripiano bianco (opz.001)
nobilitato visone (opz.948M) schiena e ripiano visone (opz.948M)



MENSOLE

di serie: altezza cm 3,8 in laminato come strutture: bianco (opz.001), perla d'oriente (opz.940), devalè grafis (opz.796), visone (opz.948M), lavagna (opz.9620), fango (opz.8860)

a richiesta: altezza cm 3,8 finiture come ante

ZOCCOLI

di serie: zoccolo H 6 in alluminio finitura titanio ossidato (opz.414)

a richiesta: zoccolo H 6 in alluminio finiture urban ossidato (opz.NU), brill (opz.412)

zoccolo H 6 in alluminio verniciato a polvere finitura opaca nei colori: nero (opz.7892), giallo ambra (opz.8225), salvia (opz.8443), rosso toscano (opz.8157), grigio nebbia (opz.9551), bianco assoluto (opz.740S), acquamarina (opz.8323), verde acqua (opz.8473), verde positano (opz.8471), castoro (opz.8907), verde lichene (opz.8463), grigio bromo (opz.9533), fumo (opz.9531), bianco caldo (opz.7401), rosa quarzo (opz.8171), blu cadetto (opz.8373),



TH. 22 MM

OLTRE **N**eck
LUX

Note: the prices are expressed in units of Euro (vat not included)

TECHNICAL FEATURES

DOORS AND DRAWER FRONTS

22 mm th. door comprised of a support in wood composite covered on two sides with class E1 HDF panels, covered in cement mortar in the following colours: old white (opt.MA11), old grey (opt.MA12), old dark (opt.MA13), old black (opt.MA14)

NECK VERSION

square edge door, for "L-SHAPED" finger rail

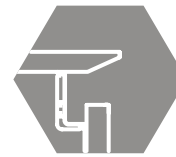

PROFILES AND FINGER RAILS LUX VERSION

standard: inclined edge door, for "L-SHAPED" finger rail
on request: inclined edge door, for flat finger rail

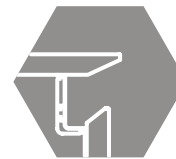

on request: aluminium inclined edge door, for "L-SHAPED" finger rail
aluminium inclined edge door, for flat finger rail

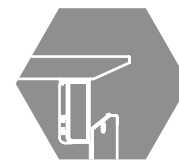
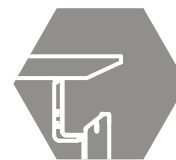

STRUCTURES

DOOR: old white
standard: melamine-coated devalè with grafis finish (opt.796), white back panel and shelf (opt.001)
DOORS: old grey, old black
standard: melamine-coated slate grey (opt.9620), slate grey back panel and shelf (opt.9620)
DOOR: old dark
standard: melamine-coated mud (opt.8860), mud back panel and shelf (opt.8860)

on request: melamine-coated oriental pearl (opt.940), white back panel and shelf (opt.001)
melamine-coated white (opt.001), white back panel and shelf (opt.001)
melamine-coated mink (opt. 948M), mink back panel and shelf (opt.948M)

SHELVES

standard: : height 3.8 cm, in laminate to match structure: white (opt.001) oriental pearl (opt.940) devalè grafis (opt.796), mink (opt.948M), slate grey (opt.9620), mud (opt.8860)

on request: height 3.8 cm, finished to match doors

PLINTHS

standard: plinth H 6 cm, in aluminium with oxidised titanium (opt.414) finish

on request: plinth H 6 cm in aluminium with oxidised urban (opt.NU), brill (opt.412) finishes
plinth H 6 cm in aluminium with matt powder coating in the following colours: black (opt.7892), amber yellow (opt.8225), sage (opt.8443), tuscan red (opt.8157), mist grey (opt.9551), absolute white (opt.740S), aquamarine (opt.8323), water green (opt.8473), positano green (opt.8471), beaver (opt.8907), lichen green (opt.8463), bromine grey (opt.9533), smoke (opt.9531), warm white (opt.7401), rose quartz (opt.8171), cadet blue (opt.8373),

SP. 22 MM TH. 22 MM

OLTRE **N**eck
Lux

anta finitura malta
door with mortar finish



old white (opz.MA11)



old grey (opz.MA12)



old dark (opz.MA13)



old black (opz.MA14)

Neck

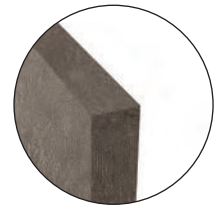

particolare anta squadrata
squared edge door detail

Lux

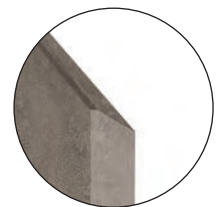

particolare anta inclinata
inclined edge door detail

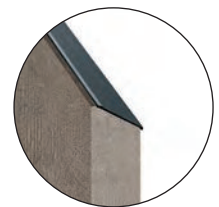

particolare anta inclinata
con profilo alluminio
inclined edge door with
aluminium profile detail

Informazioni tecniche

La malta cementizia è realizzata con impasti derivati da miscele, attentamente studiate, di leganti idraulici ed inerti, a base di farine di quarzo e sabbie minerali a granulometria controllata, esente da sali ed impurezze. A questo formulato viene aggiunta una percentuale (1÷2%) di polimeri elastomerici stabilizzanti, per evitare tensioni o crepe generate da sbalzi di temperatura e sollecitazioni dinamiche particolari. Prima dell'applicazione le superfici vengono trattate per poter permettere l'applicazione del rasante. Quest'ultimo viene applicato rigorosamente a mano da esperti artigiani su pannelli compositi. Sulla superficie, una volta asciutta, vengono applicate più mani di rivestimento acrilico trasparente: questo trattamento protegge la superficie da infiltrazioni di unto e sporco.

La particolarità del prodotto e soprattutto il modo di applicazione, ne determinano un aspetto cementizio con alcune caratteristiche proprie della sua natura, quali piccole imperfezioni, piccoli fori ed angoli non perfettamente squadrati e segni disomogenei della spatola, che esaltano la lavorazione artigianale.

Uso e manutenzione

La collezione è caratterizzata da un'adeguata resistenza alle abrasioni, ai graffi e alle possibili macchie.

È comunque molto importante un corretto trattamento e una corretta manutenzione del prodotto.

Per quanto concerne la pulizia delle superfici è indicato l'uso di detersivi neutri diluiti in acqua tiepida (proporzione 1:10, ad esempio 0,1 L di prodotto pulente e 1 L di acqua) e passati con dei semplici panni in microfibra.

È consigliato risciacquare i detersivi usati, in quanto si riduce notevolmente il rischio di usura dello strato di rivestimento a protezione della superficie. È altamente sconsigliato l'utilizzo di prodotti concentrati e di sistemi di pulizia a vapore.

Technical Information

Cement mortar is made from pastes derived from carefully blended mixtures of inert hydraulic bonding agents, comprised of quartz and mineral sands with controlled granule sizes free from salts and impurities. This formula is then blended with a percentage (1-2%) of stabilising elastomeric polymers to prevent tensions and cracks caused by temperature changes and dynamic stresses. The surfaces are treated before application to allow the coating to adhere. The coating is then applied by hand by expert craftsmen onto the composite panels. Once dry, the surface is then treated with a transparent acrylic coating: this treatment protects the surface against grease and dirt.

The special qualities of the product, and in particular the application method, create a cement effect that has certain inherent properties, such as small imperfections, tiny holes, and corners that aren't perfectly square. There may also be uneven trowel marks, all of which highlight the craft manufacture.

Use and maintenance

This collection is characterised by good resistance to abrasion, scratches and stains.

It is nonetheless very important to treat and maintain the product correctly.

With regards to cleaning surfaces, we recommend the use of neutral detergents diluted in tepid water (dilution 1:10, e.g. 0.1 L of cleaning product in 1 L of water) applied using a micro-fibre cloth.

We recommend rinsing off any detergents used as this considerably reduces the wear on the coating protecting the surface. The use of concentrated cleaning products and steam cleaning systems should be strictly avoided.

sezione anta
door section

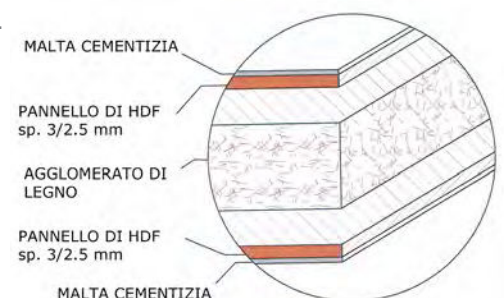



SP. 22 MM

OLTRE Neck
Lux

N.B.: i prezzi sono espressi all'unità di euro (iva esclusa)

CARATTERISTICHE TECNICHE

ANTE E FRONTALI CASSETTI

anta sp.22 mm in mdf laccata **finitura opaca testurizzata soft nei colori freddi**: bianco assoluto (opz.740S), cenere (opz.9547), argilla (opz.9503), grigio bromo (opz.9533), nero (opz.7892), blu notte (opz.8375), blu fiordaliso (opz.8377)

anta sp.22 mm in mdf laccata **finitura opaca testurizzata soft nei colori caldi**: bianco caldo (opz.7401), canapa (opz.8531), grigio kenya (opz.9501), castoro (opz.8907), fumo (opz.9531), grigio piombo (opz.9537), bistro (opz.9535), verde lichene (opz.8463), verde positano (opz.8471), giallo ambra (opz.327S), rosso toscano (opz.8157), terra di siena (opz.8161)

VERSIONE **NECK**

anta squadrata, per gola ad "ELLE"

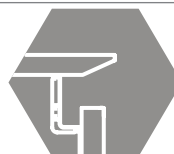

VERSIONE **LUX** PROFILI E GOLE

di serie: anta profilo inclinata per gola ad "ELLE"
a richiesta: anta profilo inclinata per gola piatta

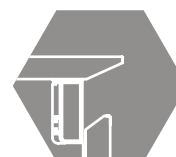
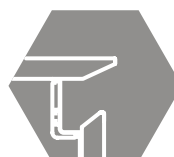

a richiesta: anta profilo alluminio inclinata per gola ad "ELLE"
anta profilo alluminio inclinata per gola piatta

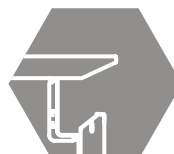

STRUTTURE

di serie: nobilitato bianco (opz.001) schiena e ripiano bianco (opz.001)

a richiesta: nobilitato visone (opz.948M) schiena e ripiano visone (opz.948M)
nobilitato lavagna (opz.9620) schiena e ripiano lavagna (opz.9620)
nobilitato devalè finitura grafis (opz.796) schiena e ripiano bianco (opz.001)
nobilitato perla d'oriente (opz.940) schiena e ripiano bianco (opz.001)
nobilitato fango (opz.8860) schiena e ripiano fango (opz.8860)



MENSOLE

di serie: altezza cm 3,8 in laminato come strutture: bianco (opz.001), perla d'oriente (opz.940), devalè grafis (opz.796), visone (opz.948M), lavagna (opz.9620), fango (opz.8860)

a richiesta: altezza cm 3,8 laccate opache finiture come ante

ZOCCOLI

di serie: zoccolo H 6 in alluminio finitura titanio ossidato (opz.414)

a richiesta: zoccolo H 6 in alluminio finiture urban ossidato (opz.NU), brill (opz.412)

zoccolo H 6 in alluminio verniciato a polvere finitura opaca nei colori: nero (opz.7892), giallo ambra (opz.8225), salvia (opz.8443), rosso toscano (opz.8157), grigio nebbia (opz.9551), bianco assoluto (opz.740S), acquamarina (opz.8323), verde acqua (opz.8473), verde positano (opz.8471), castoro (opz.8907), verde lichene (opz.8463), grigio bromo (opz.9533), fumo (opz.9531), bianco caldo (opz.7401), rosa quarzo (opz.8171), blu cadetto (opz.8373),



SP. 22 MM

N.B.: i prezzi sono espressi all'unità di euro (iva esclusa)

OLTRE **Neck**
Lux

CARATTERISTICHE TECNICHE

ANTE E FRONTALI CASSETTI

anta sp.22 mm in mdf laccata **finitura lucida spazzolata nei colori freddi**: bianco assoluto (opz.741), cenere (opz.9548), argilla (opz.9504), grigio bromo (opz.9534), nero (opz.7893), blu notte (opz.8376), blu fiordaliso (opz.8378)

anta sp.22 mm in mdf laccata **finitura lucida spazzolata nei colori caldi**: bianco caldo (opz.7402), canapa (opz.8532), grigio kenya (opz.9502), castoro (opz.8908), fumo (opz.9532), grigio piombo (opz.9538), bistro (opz.9536), verde lichene (opz.8464), verde positano (opz.8472), giallo ambra (opz.328), rosso toscano (opz.8158), terra di siena (opz.8162)

VERSIONE **NECK**

anta squadrata, per gola ad "ELLE"

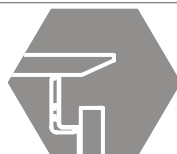

VERSIONE **LUX** PROFILI E GOLE

di serie: anta profilo inclinata per gola ad "ELLE"
a richiesta: anta profilo inclinata per gola piatta

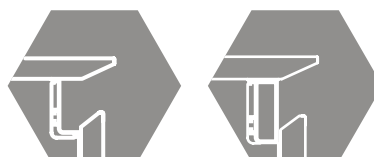

a richiesta: anta profilo alluminio inclinata per gola ad "ELLE"
anta profilo alluminio inclinata per gola piatta

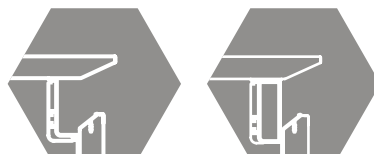

STRUTTURE

di serie: nobilitato bianco (opz.001) schiena e ripiano bianco (opz.001)

a richiesta: nobilitato visone (opz.948M) schiena e ripiano visone (opz.948M)
nobilitato lavagna (opz.9620) schiena e ripiano lavagna (opz.9620)
nobilitato devalè finitura grafis (opz.796) schiena e ripiano bianco (opz.001)
nobilitato perla d'oriente (opz.940) schiena e ripiano bianco (opz.001)
nobilitato fango (opz.8860) schiena e ripiano fango (opz.8860)



MENSOLE

di serie: altezza cm 3,8 in laminato come strutture: bianco (opz.001), perla d'oriente (opz.940), devalè grafis (opz.796), visone (opz.948M), lavagna (opz.9620), fango (opz.8860)

a richiesta: altezza cm 3,8 laccate lucide finiture come ante

ZOCCOLI

di serie: zoccolo H 6 in alluminio finitura titanio ossidato (opz.414)

a richiesta: zoccolo H 6 in alluminio finiture urban ossidato (opz.NU), brill (opz.412)

zoccolo H 6 in alluminio verniciato a polvere finitura opaca nei colori: nero (opz.7892), giallo ambra (opz.8225), salvia (opz.8443), rosso toscano (opz.8157), grigio nebbia (opz.9551), bianco assoluto (opz.740S), acquamarina (opz.8323), verde acqua (opz.8473), verde positano (opz.8471), castoro (opz.8907), verde lichene (opz.8463), grigio bromo (opz.9533), fumo (opz.9531), bianco caldo (opz.7401), rosa quarzo (opz.8171), blu cadetto (opz.8373),



cod.

G53 Neck **G63** Lux

Matt Lacquered

TH. 22 MM

OLTRE Neck
LUX

Note: the prices are expressed in units of Euro (vat not included)

TECHNICAL FEATURES

DOORS AND DRAWER FRONTS

22 mm th. MDF door, with **soft textured matt lacquered finish in the following cold colours**: absolute white (opt.740S), ash (opt.9547), clay (opt.9503), bromine grey (opt.9533), black (opt.7892), midnight blue (opt.8375), cornflower blue (opt.8377)

22 mm th. MDF door, with **soft textured matt lacquered finish in the following warm colours**: warm white (opt.7401), hemp (opt.8531), kenya grey (opt.9501), beaver (opt.8907), smoke (opt.9531), lead grey (opt.9537), bistro (opt.9535), lichen green (opt.8463), positano green (opt.8471), amber yellow (opt.327S), tuscan red (opt.8157), siena earth (opt.8161)

NECK VERSION

square edge door, for "L-SHAPED" finger rail

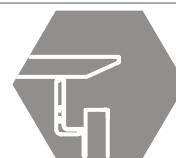

PROFILES AND FINGER RAILS LUX VERSION

standard: inclined edge door, for "L-SHAPED" finger rail
on request: inclined edge door, for flat finger rail

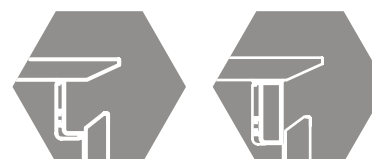

on request: aluminium inclined edge door, for "L-SHAPED" finger rail
aluminium inclined edge door, for flat finger rail

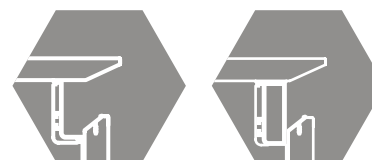

STRUCTURES

standard: melamine-coated white (opt.001), white back panel and shelf (opt.001)

on request: melamine-coated mink (opt.948M), mink back panel and shelf (opt.948M)
melamine-coated slate grey (opt.9620), slate grey back panel and shelf (opt.9620)
melamine-coated devalè with grafis finish (opt.796), white back panel and shelf (opt.001)
melamine-coated oriental pearl (opt.940), white back panel and shelf (opt.001)
melamine-coated mud (opt.8860), mud back panel and shelf (opt.8860)

SHELVES

standard: : height 3.8 cm, in laminate to match structure: white (opt.001) oriental pearl (opt.940) devalè grafis (opt.796), mink (opt.948M), slate grey (opt.9620), mud (opt.8860)

on request: height 3.8 cm, matt lacquered finish to match doors

PLINTHS

standard: plinth H 6 cm, in aluminium with oxidised titanium (opt.414) finish

on request: plinth H 6 cm in aluminium with oxidised urban (opt.NU), brill (opt.412) finishes
plinth H 6 cm in aluminium with matt powder coating in the following colours: black (opt.7892), amber yellow (opt.8225), sage (opt.8443), tuscan red (opt.8157), mist grey (opt.9551), absolute white (opt.740S), aquamarine (opt.8323), water green (opt.8473), positano green (opt.8471), beaver (opt.8907), lichen green (opt.8463), bromine grey (opt.9533), smoke (opt.9531), warm white (opt.7401), rose quartz (opt.8171), cadet blue (opt.8373),

TH. 22 MM

OLTRE **N**eck
LUX

Note: the prices are expressed in units of Euro (vat not included)

TECHNICAL FEATURES

DOORS AND DRAWER FRONTS

22 mm th. MDF door, with **brushed glossy lacquered finish in the following cold colours**: absolute white (opt.741), ash (opt.9548), clay (opt.9504), bromine grey (opt.9534), black (opt.7893), midnight blue (opt.8376), cornflower blue (opt.8378)

22 mm th. MDF door, with **brushed glossy lacquered finish in the following warm colours**: warm white (opt.7402), hemp (opt.8532), kenya grey (opt.9502), beaver (opt.8908), smoke (opt.9532), lead grey (opt.9538), bistro (opt.9536), lichen green (opt.8464), positano green (opt.8472), amber yellow (opt.328), tuscan red (opt.8158), siena earth (opt.8162)

NECK VERSION

square edge door, for "L-SHAPED" finger rail

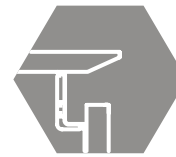

PROFILES AND FINGER RAILS LUX VERSION

standard: inclined edge door, for "L-SHAPED" finger rail
on request: inclined edge door, for flat finger rail

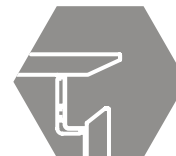

on request: aluminium inclined edge door, for "L-SHAPED" finger rail
aluminium inclined edge door, for flat finger rail

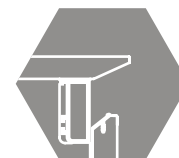
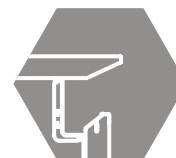

STRUCTURES

standard: melamine-coated white (opt.001), white back panel and shelf (opt.001)

on request: melamine-coated mink (opt.948M), mink back panel and shelf (opt.948M)
melamine-coated slate grey (opt.9620), slate grey back panel and shelf (opt.9620)
melamine-coated devalè with grafis finish (opt.796), white back panel and shelf (opt.001)
melamine-coated oriental pearl (opt.940), white back panel and shelf (opt.001)
melamine-coated mud (opt.8860), mud back panel and shelf (opt.8860)

SHELVES

standard: : height 3.8 cm, in laminate to match structure: white (opt.001) oriental pearl (opt.940) devalè grafis (opt.796), mink (opt.948M), slate grey (opt.9620), mud (opt.8860)

on request: height 3.8 cm, glossy lacquered finish to match doors

PLINTHS

standard: plinth H 6 cm, in aluminium with oxidised titanium (opt.414) finish

on request: plinth H 6 cm in aluminium with oxidised urban (opt.NU), brill (opt.412) finishes
plinth H 6 cm in aluminium with matt powder coating in the following colours: black (opt.7892), amber yellow (opt.8225), sage (opt.8443), tuscan red (opt.8157), mist grey (opt.9551), absolute white (opt.740S), aquamarine (opt.8323), water green (opt.8473), positano green (opt.8471), beaver (opt.8907), lichen green (opt.8463), bromine grey (opt.9533), smoke (opt.9531), warm white (opt.7401), rose quartz (opt.8171), cadet blue (opt.8373),

cod. **G53**_{Neck} **G63**_{Lux}

Laccato Opaco
Matt Lacquered

SP. 22 MM TH. 22 MM

ante laccate opache matt doors lacquered

OLTRE **N**eck
LUX



anta argilla (opz.9503)
clay door (opt.9503)



cassetto argilla (opz.9503)
clay drawer (opt.9503)



frontale cestone argilla (opz.9503)
clay deep drawer (opt.9503)

Neck

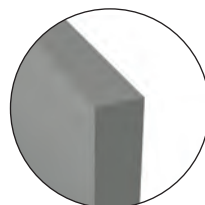

particolare anta squadrata
squared edge door detail

LUX

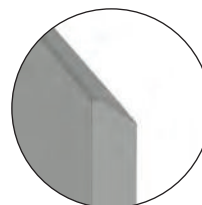

particolare anta inclinata
inclined edge door detail

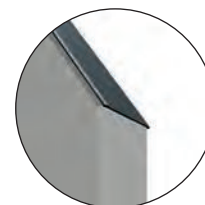

particolare anta inclinata
con profilo alluminio
inclined edge door with
aluminium profile detail

COLORI FREDDI OPACHI SOFT SOFT MATT COLD COLOURS

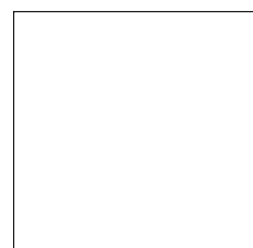

bianco assoluto (opz.740S)
absolute white

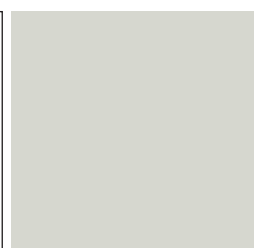

cenere (opz.9547)
ash

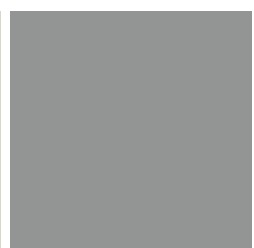

argilla (opz.9503)
clay

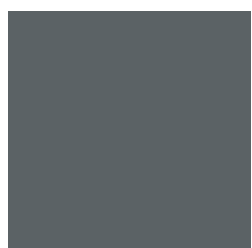

grigio bromo (opz.9533)
bromine grey

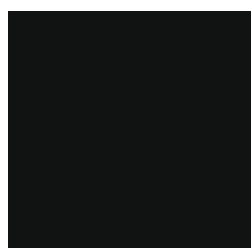

nero (opz.7892)
black

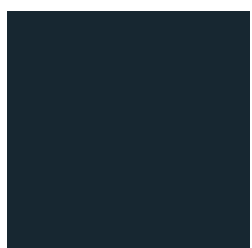

blu notte (opz.8375)
midnight blue



blu fiordaliso (opz.8377)
cornflower blue

COLORI CALDI OPACHI SOFT SOFT MATT HOT COLOURS



bianco caldo (opz.7401)
warm white

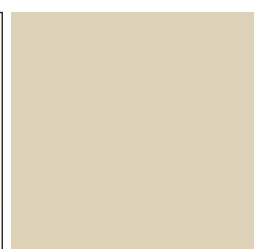

canapa (opz.8531)
hemp



grigio kenya (opz.9501)
kenya grey



castoro (opz.8907)
beaver

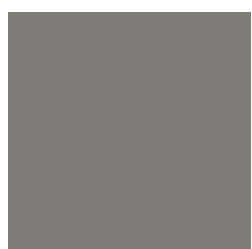

fumo (opz.9531)
smoke



grigio piombo (opz.9537)
lead grey



bistro (opz.9535)
bistro



verde lichene (opz.8463)
lichen green



verde positano (opz.8471)
positano green



giallo ambra (opz.327S)
amber yellow



rosso toscano (opz.8157)
tuscan red



terra di siena (opz.8161)
siena earth



colore a campione Ral (opz.998)
RAL sample colours

CONSEGNA: MINIMO 5 SETTIMANE DALLA CONFERMA DELL' ORDINE
DELIVERY: MINIMUM 5 WEEKS FROM ORDER CONFIRMATION

cod. **G54**_{Neck} **G64**_{Lux}

Laccato Lucido Spazzolato
Brushed Glossy Lacquered

SP. 22 MM TH. 22 MM

ante laccate lucide glossy doors lacquered

OLTRE **N**eck **L**UX



anta grigio bromo (opz.9534)
bromine grey door (opt.9534)



cassetto grigio bromo (opz.9534)
bromine grey drawer (opt.9534)



frontale cestone grigio bromo
(opz.9534)
bromine grey deep drawer (opt.9534)

Neck

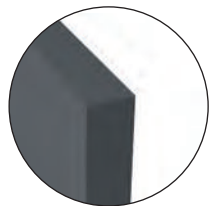

particolare anta squadrata
squared edge door detail

LUX

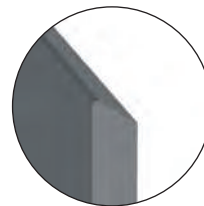

particolare anta inclinata
inclined edge door detail

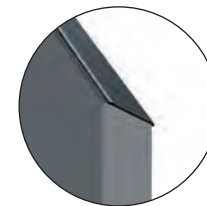

particolare anta inclinata
con profilo alluminio
inclined edge door with
aluminium profile detail

COLORI FREDDI SPAZZOLATI GLOSSY BRUSHED COLD COLOURS

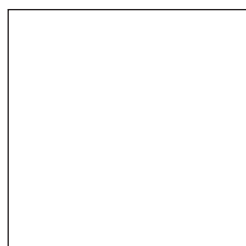

bianco assoluto (opz.741)
absolute white



cenere (opz.9548)
ash



argilla (opz.9504)
clay

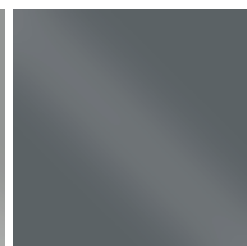

grigio bromo (opz.9534)
bromine grey

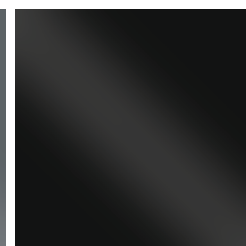

nero (opz.7893)
black

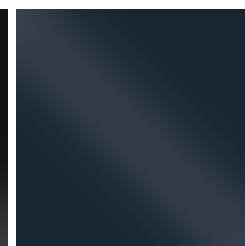

blu notte (opz.8376)
midnight blue

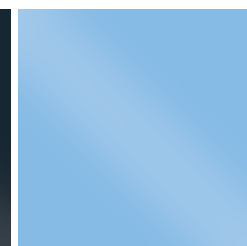

blu fiordaliso (opz.8378)
cornflower blue

COLORI CALDI SPAZZOLATI GLOSSY BRUSHED HOT COLOURS



bianco caldo (opz.7402)
warm white



canapa (opz.8532)
hemp



grigio kenia (opz.9502)
kenya grey



castoro (opz.8908)
beaver

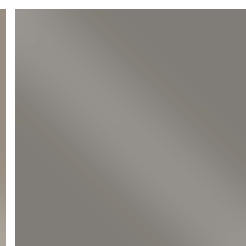

fumo (opz.9532)
smoke

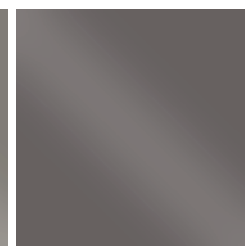

grigio piombo (opz.9538)
lead grey

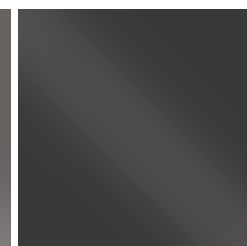

bistro (opz.9536)
bistro



verde lichene (opz.8464)
lichen green



verde positano (opz.8472)
positano green



giallo ambra (opz.328)
amber yellow



rosso toscano (opz.8158)
tuscan red

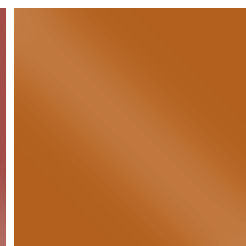

terra di siena (opz.8162)
siena earth

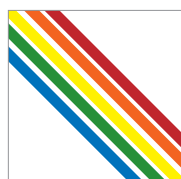

colore a campione Ral (opz.998)
RAL sample colours

CONSEGNA: MINIMO 5 SETTIMANE DALLA CONFERMA DELL' ORDINE
DELIVERY: MINIMUM 5 WEEKS FROM ORDER CONFIRMATION

cod.

G54Neck **G64**Lux

Laccato Vintage

SP. 22 MM**OLTRE** Neck
Lux

N.B.: i prezzi sono espressi all'unità di euro (iva esclusa)

CARATTERISTICHE TECNICHE**ANTE E FRONTALI
CASSETTI**anta sp.22 mm in mdf laccata **finitura semilucida effetto metallo vintage** nei colori:
peltro (opz.9549), ferro (opz.9506), urban (opz.7894), bronzo (opz.8904)**VERSIONE NECK**

anta squadrata, per gola ad "ELLE"

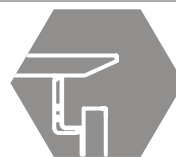
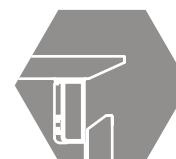
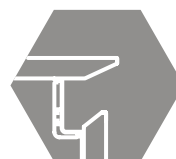
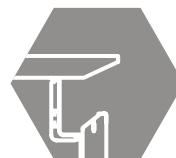
**VERSIONE LUX
PROFILI E GOLE****di serie:** anta profilo inclinata per gola ad "ELLE"
a richiesta: anta profilo inclinata per gola piatta**a richiesta:** anta profilo alluminio inclinata per gola ad "ELLE"
anta profilo alluminio inclinata per gola piatta**STRUTTURE****ANTE: peltro, ferro, urban****di serie:** nobilitato lavagna (opz.9620) schiena e ripiano lavagna (opz.9620)**ANTA: bronzo****di serie:** nobilitato fango (opz.8860) schiena e ripiano fango (opz.8860)**a richiesta:** nobilitato visone (opz.948M) schiena e ripiano visone (opz.948M)
nobilitato bianco (opz.001) schiena e ripiano bianco (opz.001)
nobilitato devalè finitura grafis (opz.796) schiena e ripiano bianco (opz.001)
nobilitato perla d'oriente (opz.940) schiena e ripiano bianco (opz.001)**MENSOLE****di serie:** altezza cm 3,8 in laminato come strutture: bianco (opz.001), perla d'oriente (opz.940), devalè grafis (opz.796), visone (opz.948M), lavagna (opz.9620), fango (opz.8860)**a richiesta:** altezza cm 3,8 finiture come ante**ZOCCOLI****di serie:** zoccolo H 6 in alluminio finitura titanio ossidato (opz.414)**a richiesta:** zoccolo H 6 in alluminio finiture urban ossidato (opz.NU), brill (opz.412)

zoccolo H 6 in alluminio verniciato a polvere finitura opaca nei colori: nero (opz.7892), giallo ambra (opz.8225), salvia (opz.8443), rosso toscano (opz.8157), grigio nebbia (opz.9551), bianco assoluto (opz.740S), acquamarina (opz.8323), verde acqua (opz.8473), verde positano (opz.8471), castoro (opz.8907), verde lichene (opz.8463), grigio bromo (opz.9533), fumo (opz.9531), bianco caldo (opz.7401), rosa quarzo (opz.8171), blu cadetto (opz.8373),



cod. **G54**_{Neck} **G64**_{Lux} Vintage Lacquered

TH. 22 MM

OLTRE **N**eck
LUX

Note: the prices are expressed in units of Euro (vat not included)

TECHNICAL FEATURES

DOORS AND DRAWER FRONTS 22 mm th. door in mdf with **vintage metal effect semi-gloss lacquer finish** in the following colours: pewter (opt. 9549), iron (opt. 9506), urban (opt. 7894), bronze (opt. 8904)

NECK VERSION square edge door, for "L-SHAPED" finger rail

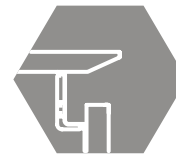

PROFILES AND FINGER RAILS LUX VERSION **standard:** inclined edge door, for "L-SHAPED" finger rail
on request: inclined edge door, for flat finger rail

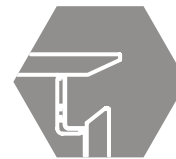

on request: aluminium inclined edge door, for "L-SHAPED" finger rail
aluminium inclined edge door, for flat finger rail

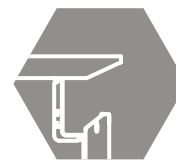

STRUCTURES **DOORS: pewter, iron, urban**
standard: melamine-coated slate grey (opt.9620), slate grey back panel and shelf (opt.9620)
DOOR: bronze
standard: melamine-coated mud (opt.8860), mud back back panel and shelf (opt.8860)

on request: melamine-coated mink (opt.948M), mink back panel and shelf (opt.948M)
melamine-coated white (opt.001), white back panel and shelf (opt.001)
melamine-coated devalè with grafis finish (opt.796), white back panel and shelf (opt.001)
melamine-coated oriental pearl (opt.940), white back panel and shelf (opt.001)

SHELVES **standard:** : height 3.8 cm, in laminate to match structure: white (opt. 001) oriental pearl (opt. 940) devalè grafis (opt. 796), mink (opt. 948M), slate grey (opt. 9620), mud (opt. 8860)

on request: height 3.8 cm, finished to match doors

PLINTHS **standard:** plinth H 6 cm, in aluminium with oxidised titanium (opt.414) finish
on request: plinth H 6 cm in aluminium with oxidised urban (opt.NU), brill (opt.412) finishes
plinth H 6 cm in aluminium with matt powder coating in the following colours: black (opt.7892), amber yellow (opt.8225), sage (opt.8443), tuscan red (opt.8157), mist grey (opt.9551), absolute white (opt.740S), aquamarine (opt.8323), water green (opt.8473), positano green (opt.8471), beaver (opt.8907), lichen green (opt.8463), bromine grey (opt.9533), smoke (opt.9531), warm white (opt.7401), rose quartz (opt.8171), cadet blue (opt.8373),

cod. **G54**_{Neck} **G64**_{Lux}

Laccato Vintage
Vintage Lacquered

SP. 22 MM TH. 22 MM

ante laccate vintage effetto metallo
lacquered vintage doors metal effect

OLTRE **N**eck
LUX



anta peltro (opz.9549)
pewter door (opt.9549)



anta ferro (opz.9506)
iron door (opt.9506)



anta urban (opz.7894)
urban door (opt.7894)



anta bronzo (opz.8904)
bronze door (opt.8904)

Neck

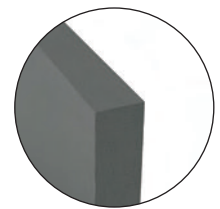

particolare anta squadrata
squared edge door detail

LUX

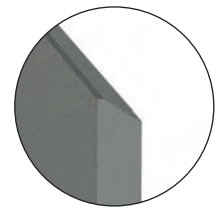

particolare anta inclinata
inclined edge door detail

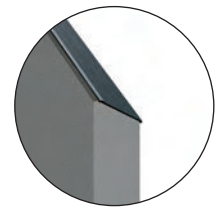

particolare anta inclinata
con profilo alluminio
inclined edge door with
aluminium profile detail



abbinabile alle versioni: G50-G51-G52-G53-G54

matched with versions: G50-G51-G52-G53-G54

di serie: telaio alluminio sp.22 mm verniciato a polvere nero,
vetro temperato master line sp.4 mm (opz.NML)

standard: 22mm th. aluminium frame with black powder coating, 4mm th. master line tempered glass (opt.NML)



particolare telaio svasatura esterna
detail frame with external flared

Neck



particolare anta squadrata
squared edge door detail

SP. 22 MM TH. 22 MM

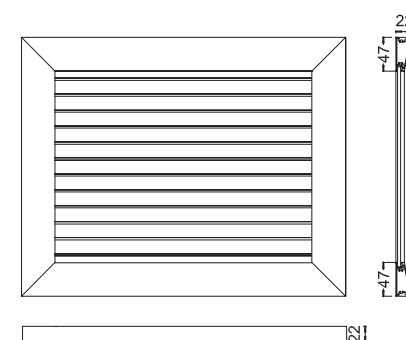

a richiesta: telaio alluminio sp.22 mm finitura urban ossidato

vetro bronzo temperato serigrafato in glitter decoro retinato sp.4 mm (opz.NUBR)

on request: 22 mm th. aluminium frame with urban oxidized finish, 4mm th. screen-printed tempered bronze glass with glitter mesh decor (opt.NUBR)



Neck

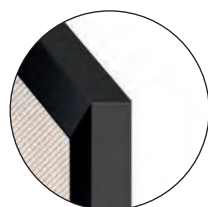

particolare anta squadrata
squared edge door detail

SP. 22 MM TH. 22 MM

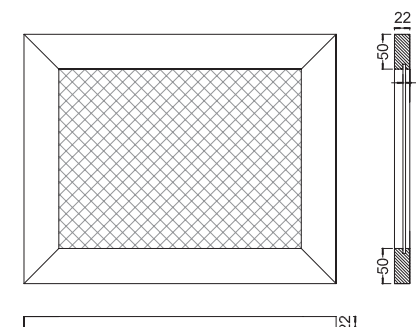

abbinabile alle versioni: G50-G51-G52-G53-G54

matched with versions: G50-G51-G52-G53-G54

a richiesta: telaio alluminio sp.22 mm finitura urban ossidato con pannello in lamiera stirata in alluminio effetto rete anodizzata nera (opz.NUR)

on request: 22 mm th. aluminium frame with urban oxidized finish and aluminium stretched metal sheet panel with black anodised mesh effect (opt.NUR)



Neck

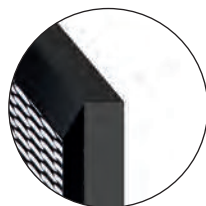

particolare anta squadrata
squared edge door detail

SP. 22 MM TH. 22 MM

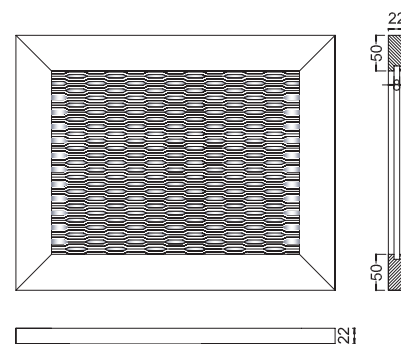

a richiesta: telaio alluminio sp.22 mm finitura urban ossidato con pannello in mdf idro placcato 2 lati in laminato lavagna nero (opz.NUL)

on request: 22 mm th. aluminium frame with urban oxidized finish, with idro mdf plated with blackboard laminate on both sides (opt.NUL)



Neck

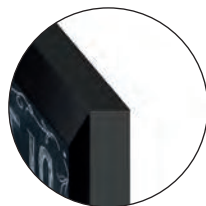

particolare anta squadrata
squared edge door detail

SP. 22 MM TH. 22 MM

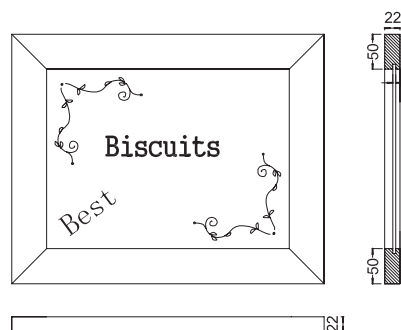

SP. 22 MM

OLTRE **N**eck
LUX

N.B.: i prezzi sono espressi all'unità di euro (iva esclusa)

CARATTERISTICHE TECNICHE

ANTE E FRONTALI CASSETTI

telaio alluminio sp.22 mm verniciato a polvere finitura opaca in tinta con il vetro, tamburato nella parte posteriore con pannello in HDF grigio cenere sp.3 mm.

Vetro temperato satinato sp.4 mm laccato nei colori **freddi**:
bianco assoluto (opz.V740S), cenere (opz.V9547), grigio bromo (opz.V9533), nero (opz.V7892)

Vetro temperato satinato sp.4 mm laccato nei colori **caldi**:
bianco caldo (opz.V7401), canapa (opz.V8531), castoro (opz.V8907), fumo (opz.V9531), verde lichene (opz.V8463), bistro (opz.V9535), rosso toscano (opz.V8157), giallo ambra (opz.V327S), grigio piombo (opz.V9537), verde positano (opz.V8471), bronzo (opz.V8903)

VERSIONE **NECK**

anta squadrata, per gola ad "ELLE"

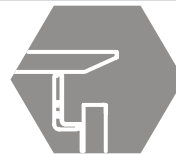

VERSIONE **LUX** PROFILI E GOLE

di serie: anta profilo inclinata per gola ad "ELLE"
a richiesta: anta profilo inclinata per gola piatta

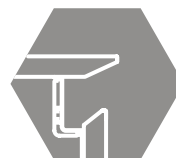

STRUTTURE

di serie: nobilitato bianco (opz.001) schiena e ripiano bianco (opz.001)

a richiesta: nobilitato visone (opz.948M) schiena e ripiano visone (opz.948M)
nobilitato lavagna (opz.9620) schiena e ripiano lavagna (opz.9620)
nobilitato devalè finitura grafis (opz.796) schiena e ripiano bianco (opz.001)
nobilitato perla d'oriente (opz.940) schiena e ripiano bianco (opz.001)
nobilitato fango (opz.8860) schiena e ripiano fango (opz.8860)



MENSOLE

di serie: altezza cm 3,8 in laminato come strutture: bianco (opz.001), perla d'oriente (opz.940), devalè grafis (opz.796), visone (opz.948M), lavagna (opz.9620), fango (opz.8860)

a richiesta: altezza cm 3,8 laccate opache finitura come ante laccate

ZOCCOLI

di serie: zoccolo H 6 in alluminio finitura titanio ossidato (opz.414)

a richiesta: zoccolo H 6 in alluminio finiture urban ossidato (opz.NU), brill (opz.412)

zoccolo H 6 in alluminio verniciato a polvere finitura opaca nei colori: nero (opz.7892), giallo ambra (opz.8225), salvia (opz.8443), rosso toscano (opz.8157), grigio nebbia (opz.9551), bianco assoluto (opz.740S), acquamarina (opz.8323), verde acqua (opz.8473), verde positano (opz.8471), castoro (opz.8907), verde lichene (opz.8463), grigio bromo (opz.9533), fumo (opz.9531), bianco caldo (opz.7401), rosa quarzo (opz.8171), blu cadetto (opz.8373),



cod. **G56**_{Neck} **G66**_{Lux}

Vetro Lucido

SP. 22 MM

OLTRE **Neck**
LUX

N.B.: i prezzi sono espressi all'unità di euro (iva esclusa)

CARATTERISTICHE TECNICHE

ANTE E FRONTALI CASSETTI

telaio alluminio sp.22 mm verniciato a polvere finitura opaca in tinta con il vetro, tamburato nella parte posteriore con pannello in HDF grigio cenere sp.3 mm.

Vetro temperato lucido sp.4 mm laccato nei colori **freddi**:
bianco assoluto (opz.V741), cenere (opz.V9548), grigio bromo (opz.V9534), nero (opz.V7893)

Vetro temperato lucido sp.4 mm laccato nei colori **caldi**:
bianco caldo (opz.V7402), canapa (opz.V8532), castoro (opz.V8908), fumo (opz.V9532), verde lichene (opz.V8464), bistro (opz.V9536), rosso toscano (opz.V8158), giallo ambra (opz.V328), grigio piombo (opz.V9538), verde positano (opz.V8472), bronzo (opz.V8904)

VERSIONE **NECK**

anta squadrata, per gola ad "ELLE"

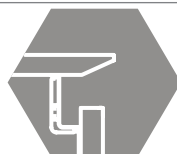

VERSIONE **LUX** PROFILI E GOLE

di serie: anta profilo inclinata per gola ad "ELLE"
a richiesta: anta profilo inclinata per gola piatta

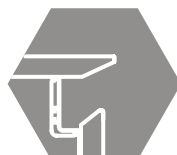

STRUTTURE

di serie: nobilitato bianco (opz.001) schiena e ripiano bianco (opz.001)

a richiesta: nobilitato visone (opz.948M) schiena e ripiano visone (opz.948M)
nobilitato lavagna (opz.9620) schiena e ripiano lavagna (opz.9620)
nobilitato devalè finitura grafis (opz.796) schiena e ripiano bianco (opz.001)
nobilitato perla d'oriente (opz.940) schiena e ripiano bianco (opz.001)
nobilitato fango (opz.8860) schiena e ripiano fango (opz.8860)



MENSOLE

di serie: altezza cm 3,8 in laminato come strutture: bianco (opz.001), perla d'oriente (opz.940), devalè grafis (opz.796), visone (opz.948M), lavagna (opz.9620), fango (opz.8860)

a richiesta: altezza cm 3,8 laccate lucide finitura come ante laccate

ZOCCOLI

di serie: zoccolo H 6 in alluminio finitura titanio ossidato (opz.414)

a richiesta: zoccolo H 6 in alluminio finiture urban ossidato (opz.NU), brill (opz.412)

zoccolo H 6 in alluminio verniciato a polvere finitura opaca nei colori: nero (opz.7892), giallo ambra (opz.8225), salvia (opz.8443), rosso toscano (opz.8157), grigio nebbia (opz.9551), bianco assoluto (opz.740S), acquamarina (opz.8323), verde acqua (opz.8473), verde positano (opz.8471), castoro (opz.8907), verde lichene (opz.8463), grigio bromo (opz.9533), fumo (opz.9531), bianco caldo (opz.7401), rosa quarzo (opz.8171), blu cadetto (opz.8373),



NECK-LUX

cod.

G55 Neck **G65** Lux

Satin Glass

TH. 22 MM

OLTRE Neck
LUX

Note: the prices are expressed in units of Euro (vat not included)

TECHNICAL FEATURES

DOORS AND DRAWER FRONTS

Aluminium frame Th.22 mm dust painted with matt finish matching with the glass and back coated with an HDF panel colour ash grey

Hardened satin glass, lacquered in the following **cold** colours:
absolute white (opt.V740S), ash (opt.V9547), bromine grey (opt.V9533), black (opt.V7892)

Hardened satin glass, lacquered in the following **hot** colours:
warm white (opt.V7401), hemp (opt.V8531), beaver (opt.V8907), smoke (opt.V9531), lichen green (opt.V8463), bistro (opt.V9535), tuscan red (opt.V8157), amber yellow (opt.V327S), lead grey (opt.V9537), positano green (opt.V8471), bronze (opt.V8903)

NECK VERSION

square edge door, for "L-SHAPED" finger rail

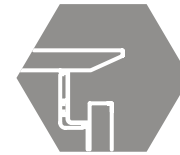

PROFILES AND FINGER RAILS **LUX** VERSION
standard: inclined edge door, for "L-SHAPED" finger rail
on request: inclined edge door, for flat finger rail

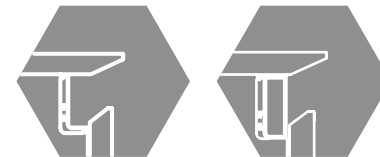

STRUCTURES

standard: melamine-coated white (opt.001), white back panel and shelf (opt.001)

on request: melamine-coated mink (opt.948M), mink back panel and shelf (opt.948M)
melamine-coated slate grey (opt.9620), slate grey back panel and shelf (opt.9620)
melamine-coated devalè with grafis finish (opt.796), white back panel and shelf (opt.001)
melamine-coated oriental pearl (opt.940), white back panel and shelf (opt.001)
melamine-coated mud (opt.8860), mud back panel and shelf (opt.8860)

SHELVES

standard: : height 3.8 cm, in laminate to match structure: white (opt.001) oriental pearl (opt.940) devalè grafis (opt.796), mink (opt.948M), slate grey (opt.9620), mud (opt.8860)

on request: height 3.8 cm, matt lacquered same finish as laquered doors

PLINTHS

standard: plinth H 6 cm, in aluminium with oxidised titanium (opt.414) finish

on request: plinth H 6 cm in aluminium with oxidised urban (opt.NU), brill (opt.412) finishes
plinth H 6 cm in aluminium with matt powder coating in the following colours: black (opt.7892), amber yellow (opt.8225), sage (opt.8443), tuscan red (opt.8157), mist grey (opt.9551), absolute white (opt.740S), aquamarine (opt.8323), water green (opt.8473), positano green (opt.8471), beaver (opt.8907), lichen green (opt.8463), bromine grey (opt.9533), smoke (opt.9531), warm white (opt.7401), rose quartz (opt.8171), cadet blue (opt.8373),

cod. **G56**_{Neck} **G66**_{Lux}

Glossy Glass

TH. 22 MM

OLTRE **N**eck
Lux

Note: the prices are expressed in units of Euro (vat not included)

TECHNICAL FEATURES

DOORS AND DRAWER FRONTS

aluminium frame Th.22 mm dust painted with matt finish matching with the glass and back coated with an HDF panel colour ash grey

Hardened glossy glass, lacquered in the following **cold** colours:
absolute white (opt.V741), ash (opt.V9548), bromine grey (opt.V9534), black (opt.V7893)

Hardened glossy glass, lacquered in the following **hot** colours:
warm white (opt.V7402), hemp (opt.V8532), beaver (opt.V8908), smoke (opt.V9532), lichen green (opt.V8464), bistro (opt.V9536), tuscan red (opt.V8158), amber yellow (opt.V328), lead grey (opt.V9538), positano green (opt.V8472), bronze (opt.V8904)

NECK VERSION

square edge door, for "L-SHAPED" finger rail

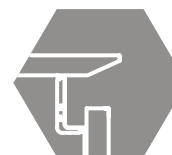

PROFILES AND FINGER
RAILS **LUX** VERSION **standard:** inclined edge door, for "L-SHAPED" finger rail
on request: inclined edge door, for flat finger rail

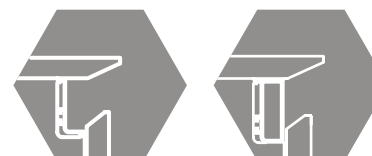

STRUCTURES

standard: melamine-coated white (opt.001), white back panel and shelf (opt.001)

on request: melamine-coated mink (opt.948M), mink back panel and shelf (opt.948M)
melamine-coated slate grey (opt.9620), slate grey back panel and shelf (opt.9620)
melamine-coated devalè with grafis finish (opt.796), white back panel and shelf (opt.001)
melamine-coated oriental pearl (opt.940), white back panel and shelf (opt.001)
melamine-coated mud (opt.8860), mud back panel and shelf (opt.8860)

SHELVES

standard: : height 3.8 cm, in laminate to match structure: white (opt.001) oriental pearl (opt.940) devalè grafis (opt.796), mink (opt.948M), slate grey (opt.9620), mud (opt.8860)

on request: height 3.8 cm, glossy lacquered same finish as laquered doors

PLINTHS

standard: plinth H 6 cm, in aluminium with oxidised titanium (opt.414) finish

on request: plinth H 6 cm in aluminium with oxidised urban (opt.NU), brill (opt.412) finishes
plinth H 6 cm in aluminium with matt powder coating in the following colours: black (opt.7892), amber yellow (opt.8225), sage (opt.8443), tuscan red (opt.8157), mist grey (opt.9551), absolute white (opt.740S), aquamarine (opt.8323), water green (opt.8473), positano green (opt.8471), beaver (opt.8907), lichen green (opt.8463), bromine grey (opt.9533), smoke (opt.9531), warm white (opt.7401), rose quartz (opt.8171), cadet blue (opt.8373),

cod. **G55** Neck **G65** Lux

Vetro Satinato
Satin Glass

OLTRE **N**eck
LUX

SP. 22 MM TH. 22 MM

anta vetro satinato
satin glass door

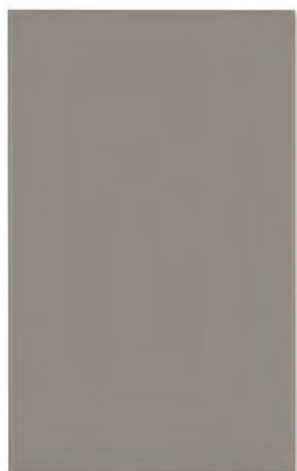

telaio alluminio, vetro fumo (opz.V9531)
aluminum frame, smoke glass (opt.V9531)



particolare retro anta grigio cenere
detail of the back side of the door,
ash grey colour

Neck

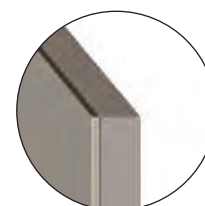

particolare anta squadrata
squared edge door detail

COLORI FREDDI SATINATI SATIN COLD COLOURS

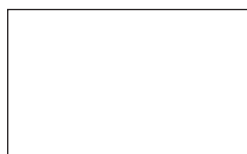

bianco assoluto
satinato (opz.V740S)
satin absolute white

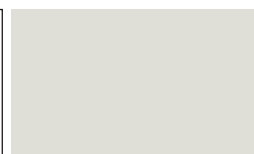

cenere satinato
(opz.V9547)
satin ash



grigio bromo satinato
(opz.V9533)
satin bromine grey

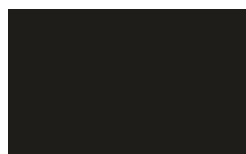

nero satinato
(opz.V7892)
satin black

LUX

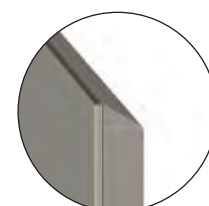

particolare anta inclinata
inclined edge door detail

COLORI CALDI SATINATI SATIN HOT COLOURS

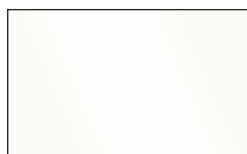

bianco caldo satinato
(opz.V740I)
satin warm white



canapa satinato
(opz.V8531)
satin hemp



castoro satinato
(opz.V8907)
satin beaver



fumo satinato
(opz.V9531)
satin smoke



verde lichene satinato
(opz.V8463)
satin lichen green



bistro satinato
(opz.V9535)
satin bistro



rosso toscano satinato
(opz.V8157)
satin tuscan red



giallo ambra satinato
(opz.V327S)
satin amber yellow



grigio piombo satinato
(opz.V9537)
satin lead grey



verde positano satinato
(opz.V8471)
satin positano green



bronzo satinato
(opz.V8903)
satin bronze

SP. 22 MM TH. 22 MM

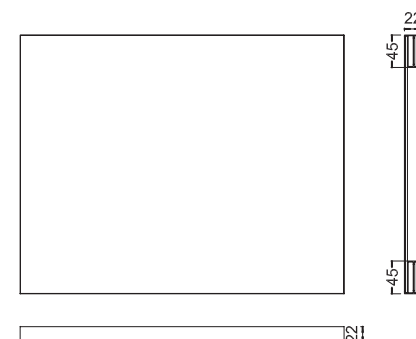

cod. **G56** Neck **G66** Lux

Vetro Lucido
Glossy Glass

OLTRE **N**eck
LUX

SP. 22 MM TH. 22 MM

anta vetro lucido
glossy glass doors



telaio alluminio, vetro fumo (opz.V9532)
aluminum frame, smoke glass (opt.V9532)



particolare retro anta grigio cenere
detail of the back side of the door,
ash grey colour

Neck

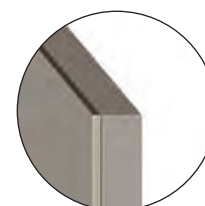

particolare anta squadrata
squared edge door detail

LUX

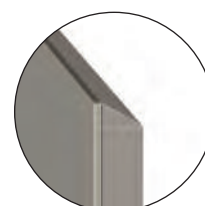

particolare anta inclinata
inclined edge door detail

COLORI FREDDI LUCIDO GLOSSY COLD COLOURS



bianco assoluto lucido (opz.V741) glossy absolute white
cenere lucido (opz.V9548) glossy ash
grigio bromo lucido (opz.V9534) glossy bromine grey
nero lucido (opz.V7893) glossy black

COLORI CALDI LUCIDO GLOSSY HOT COLOURS



bianco caldo lucido (opz.V7402) glossy warm white
canapa lucido (opz.V8532) glossy hemp
castoro lucido (opz.V8908) glossy beaver
fumo lucido (opz.V9532) glossy smoke



verde lichene lucido (opz.V8464) glossy lichen green
bistro lucido (opz.V9536) glossy bistro
rosso toscano lucido (opz.V8158) glossy tuscan red
giallo ambra lucido (opz.V328) glossy amber yellow



grigio piombo lucido (opz.V9538) glossy lead grey
verde positano lucido (opz.V8472) glossy positano green
bronzio lucido (opz.V8904) glossy bronze

SP. 22 MM TH. 22 MM

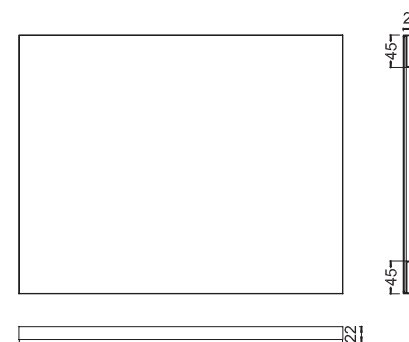

strutture carcasses



bianco (opz.001)
schiena e ripiano bianco
(opz.001)
white (opt.001)
white back panel and shelf
(opt.001)



perla d'oriente (opz.940)
schiena e ripiano bianco
(opz.001)
oriental pearl (opt.940)
white back panel and shelf
(opt.001)



devalè finitura grafis
(opz.796) schiena e ripiano
bianco (opz.001)
devalè with grafis finish
(opt.796)
white back panel and shelf
(opt.001)



visone (opz.948M)
schiena e ripiano visone
(opz.948M)
mink (opt.948M)
mink back panel and shelf
(opt.948M)



lavagna (opz.9620)
schiena e ripiano lavagna
(opz.9620)
slate grey (opt.9620)
slate grey back panel
and shelf (opt.9620)



fango (opz.8860)
schiena e ripiano fango
(opz.8860)
mud (opt.8860)
mud back panel and shelf
(opt.8860)



LUBE ECOLOGIC

IL GRUPPO LUBE HA SCELTO DI UTILIZZARE PER I COMPONENTI COSTITUENTI LE STRUTTURE DELLE CUCINE SOLO MATERIALE A BASSISSIMA EMISSIONE DI FORMALDEIDE: CONFORMI ALLO STANDARD F**** SECONDO LA NORMA JIS, CERTIFICATO DAL MINISTERO GIAPPONESE, IL PIÙ SEVERO IN MERITO ALLE NORMATIVE DI SALVAGUARDIA AMBIENTALE.

LUBE GROUP HAS CHOSEN TO EXCLUSIVELY USE MATERIALS WITH VERY LOW FORMALDEHYDE EMISSIONS FOR THE COMPONENTS MAKING UP THE KITCHEN CARCASSES: THESE ELEMENTS COMPLY WITH THE F4 STAR STANDARD ACCORDING TO JIS, CERTIFIED BY THE JAPANESE GOVERNMENT - THE MOST STRINGENT WHEN IT COMES TO ENVIRONMENTAL PROTECTION.

mensole in laminato P 31-61 come strutture same colours as carcasses laminate shelves D 31-61



bianco (opz.001)
white (opt.001)



perla d'oriente (opz.940)
oriental pearl (opt.940)



devalè finitura grafis (opz.796)
devalè with grafis finish (opt.796)

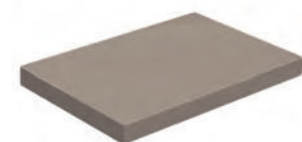

visone (opz.948M)
mink (opt.948M)

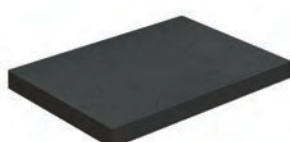

lavagna (opz.9620)
slate grey (opt.9620)

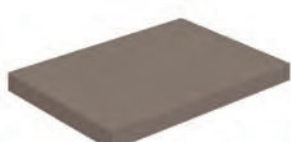

fango (opz.8860)
mud (opt.8860)

mensole impiallacciate veneered shelves



impiallacciata come anta
N.B.: per le finiture vedi pagine 20-21
veneered same finish as door
Note: for the finishes see pages 20-21

mensole fenix fenix shelves

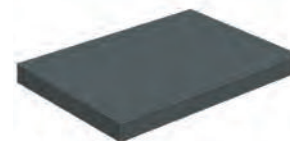

fenix come anta
N.B.: per le finiture vedi pagina 24
fenix as door
Note: for the finishes see page 24

mensole malta malta shelves



malta come anta
N.B.: per le finiture vedi pagina 28
malta as door
Note: for the finishes see page 28

mensole laccate lacquered shelves



laccate opache e lucide come anta
N.B.: per le finiture vedi pagine 34-35
matt and glossy lacquered as door
Note: for the finishes see pages 34-35

mensole laccate vintage vintage lacquered shelves



laccate vintage come anta
N.B.: per le finiture vedi pagina 38
vintage lacquered as door
Note: for the finishes see page 38

zoccoli in alluminio H 6 aluminium plinth H 6



alluminio finitura titanio
ossidato (opz.414)
aluminium titanium
oxidized finish (opt.414)

zoccoli in alluminio H 6 aluminium plinth H 6

a richiesta
on request



alluminio finitura urban
ossidato (opz.NU)
aluminium urban
oxidized finish (opt.NU)

alluminio
finitura brill (opz.412)
aluminium
brill finish (opt.412)

zoccoli in alluminio H 6 verniciati a polvere finitura opaca aluminum plinth height H 6 powder coated matt finish



alluminio finitura nero
(opz.7892)
aluminium
black finish (opt.7892)

alluminio finitura fumo
(opz.9531)
aluminium
smoke finish (opt.9531)

alluminio finitura
bianco caldo (opz.7401)
aluminium warm white
finish (opt.7401)

alluminio finitura
bianco assoluto (opz.740S)
aluminium absolute
white finish (opt.740S)



alluminio finitura
verde positano
(opz.8471)
aluminium positano
green finish (opt.8471)

alluminio finitura
acquamarina
(opz.8323)
aluminium
aquamarine finish
(opt.8323)

alluminio finitura giallo
ambra (opz.8225)
aluminium amber
yellow finish (opt.8225)

alluminio finitura salvia
(opz.8443)
aluminium sage
finish (opt.8443)



alluminio finitura rosa
quarzo (opz.8171)
aluminium quartz
pink finish (opt.8171)

alluminio finitura grigio
bromo (opz.9533)
aluminium bromine
grey finish (opt.9533)

alluminio finitura
castoro (opz.8907)
aluminium beaver
finish (opt.8907)

alluminio finitura rosso
toscano (opz.8157)
aluminium tuscan red
finish (opt.8157)

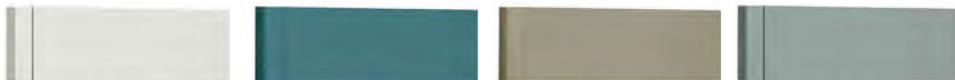

alluminio finitura grigio
nebbia (opz.9551)
aluminium fog grey
finish (opt.9551)

alluminio blu cadetto
(opz.8373)
aluminium cadet blue
finish (opt.8373)

alluminio finitura verde
lichene (opz.8463)
aluminium lichen green
finish (opt.8463)

alluminio finitura
verde acqua (opz.8473)
aluminium water green
finish (opt.8473)

top H 4 consigliati in laminato bordo ABS 1 recommended laminate worktops H 4 with ABS 1 edge

bianco finitura velvet (opz.800) white with velvet finish	bianco latte finitura wraky (opz.813) milk white with wraky finish	grigio chiaro finitura plamky (opz.1366) light grey with plamky finish	corda finitura plamky (opz.1109) jute with plamky finish	finto marmo brown finitura plamky (opz.5555) false marble brown with plamky finish
travertino beige con stuccature finitura plamky (opz.5548) travertine beige with putty plamky finish	sabbia vintage finitura plamky (opz.783) vintage sand with plamky finish	calce finitura wraky (opz.814) whitewash with wraky finish	travertino finitura luna (opz.8753) travertine with luna finish	cuoio finitura luna (opz.8730) leather with luna finish
acciaio invecchiato finitura velvet (opz.5550) aged steel laminate with velvet finish	basalto cenere finitura mika (opz.3342) ash basalt with mika finish	tortora finitura plamky (opz.1027) dove grey with plamky finish	bianco assoluto finitura mika (opz.822) absolute white with mika finish	luserna finitura luna (opz.3366) luserna with luna finish
cemento finitura plamky (opz.6066) cement with plamky finish	liberty finitura plamky (opz.932) liberty with plamky finish	nero finitura flatting (opz.853) black with flatting finish	travertino naturale finitura climb (opz.547) natural travertine with climb finish	old white finitura urban (opz.LM11) old white with urban finish
old grey finitura urban (opz.LM12) old grey with urban finish	old dark finitura urban (opz.LM13) old dark with urban finish	old black finitura urban (opz.LM14) old black with urban finish	peltro (opz.L934) pewter (opt.L934)	ferro (opz.L933) iron (opt.L933)

top H 4 consigliati in laminato Fenix recommended laminate worktops H 4 with Fenix

bianco alaska (opz.0030) alaska white	bianco malè (opz.0029) malè white	beige (opz.0719) beige	castoro (opz.0717) beaver	fumo (opz.0718) smoke
grigio bromo (opz.0724) bromine grey	nero (opz.0720) black	bronzo doha (opz.2629) doha bronze	bianco caldo (opz.0032) warm white	

top H 4 consigliati in laminato Unicolor recommended laminate worktops H 4 with Unicolor

bianco neve opaco (opz.001) matt snow white	bianco assoluto opaco (opz.002) matt absolute white	pietra bianca finitura wraky (opz.753) white stone with wraky finish	bianco opaco finitura stardust (opz.500) matt white with stardust finish	grigio chiaro opaco (opz.100) matt light grey
visone opaco finitura velvet (opz.1027) matt mink with velvet finish	tortora opaco finitura velvet (opz.1594) matt dove grey with velvet finish	acoma opaco finitura touch (opz.5545) matt acoma with touch finish	grigio vulcano finitura wraky (opz.6062) volcano grey with wraky finish	rovere menphis finitura alevè (opz.664N) menphis oak with alevè finish
rovere antracite finitura tranchè (opz.772) anthracite oak with tranchè finish				

MODULARITÀ E COMPONENTIBILITÀ MODULARITY AND FITTING SOLUTIONS

- ESCLUSO 65 EXCLUDING 65
- ESCLUSO 45 EXCLUDING 45
- ESCLUSO 120 EXCLUDING 120
- SOLO 90 ONLY 90

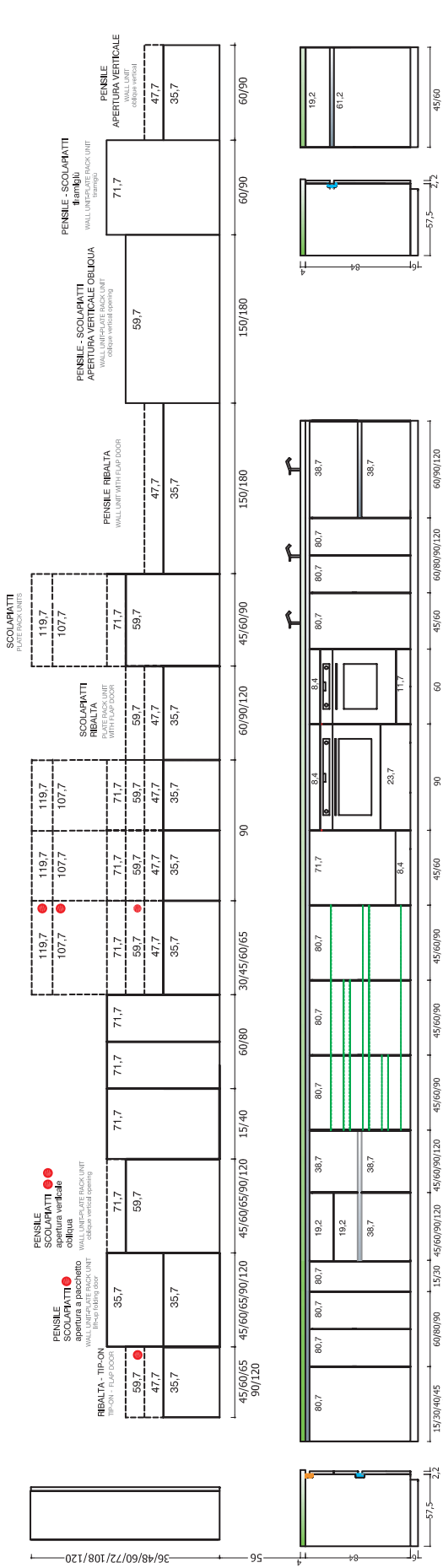

BASI H 75
BASE UNITS H 75

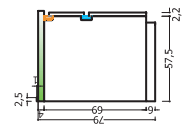

BASILING
ROOM UNITS

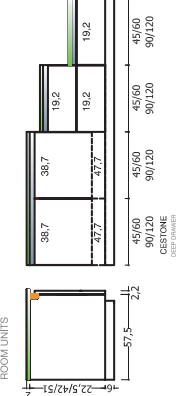

BASI ISOPESE
HANGING BASE UNITS

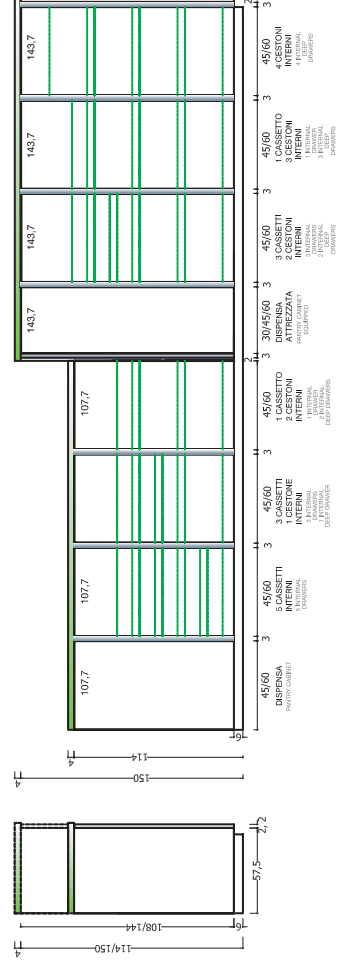
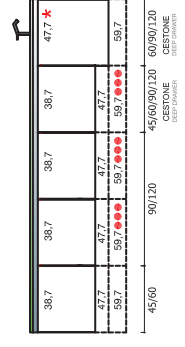

MODULARITÀ E COMPONIBILITÀ MODULARITY AND FITTING SOLUTIONS

COLONNE
COLUMNS

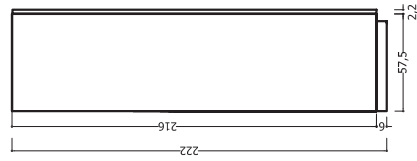

COLONNE FRIGO
FRIDGE COLUMNS

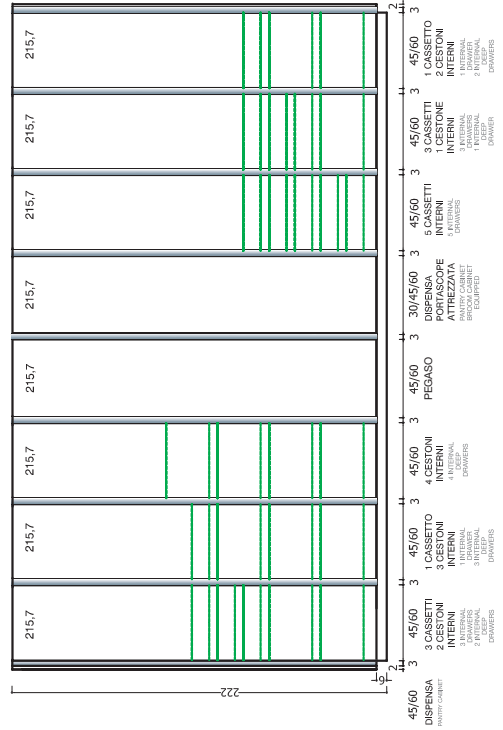
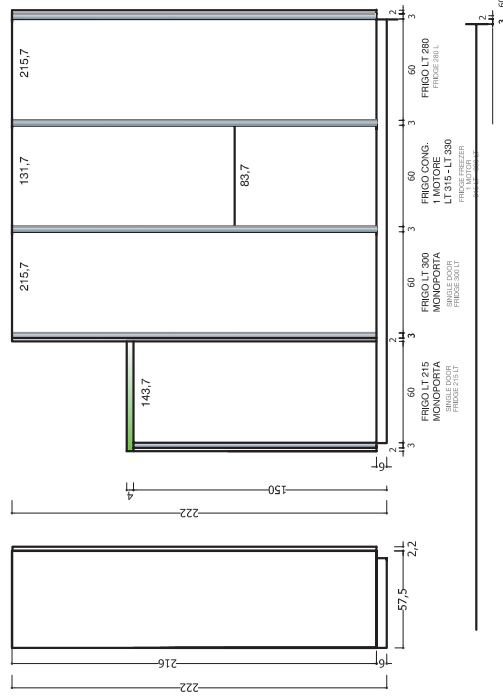

COLONNE FORNO
OVEN COLUMNS

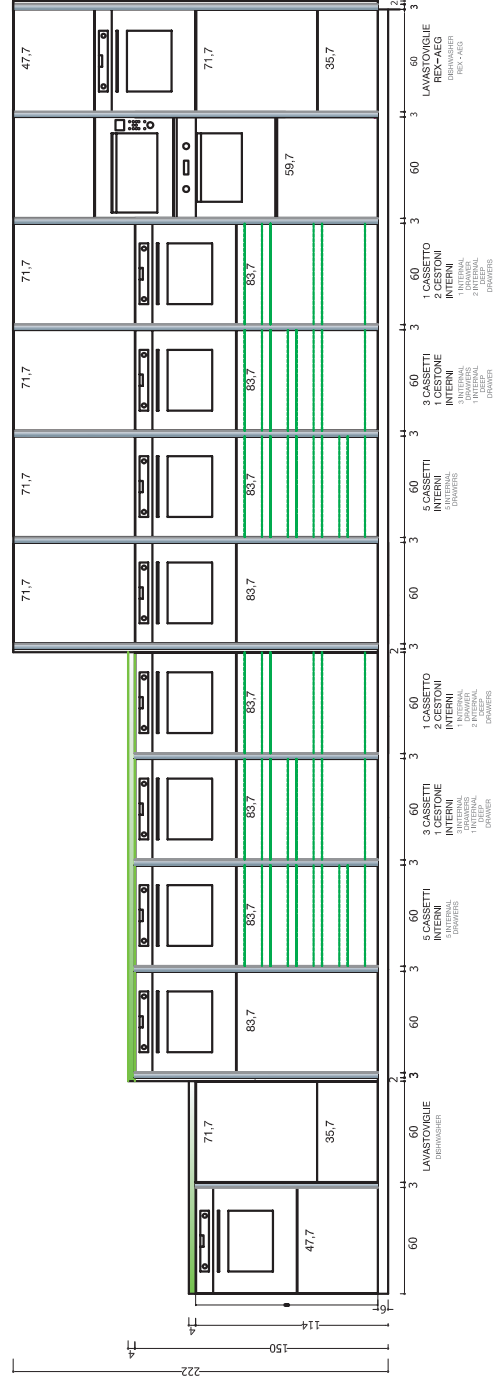
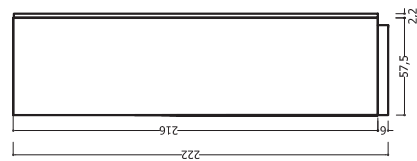

LA COLLEZIONE BRIDGE DEL PROGRAMMA
OLTRE PRESENTA UNA GRANDE VARIETA' DI
MANIGLIE, DI VARIE FORME,
MATERIALI, DIMENSIONI E FINITURE,
CREATE AD HOC PER DARE UNICITA'
E PERSONALITA' AD OGNI CUCINA.

THE BRIDGE COLLECTION OF OLTRE PROGRAM PROPOSE A WIDE
RANGE OF HANDLES, IN VARIOUS FORMS,
MATERIALS, DIMENSIONS AND FINISHES,
SPECIFICALLY CREATED TO GIVE UNIQUENESS AND PERSONALITY
TO EACH KITCHEN.

OLTRE

Bridge



FRONTALE
anta con maniglia frontale
door with front handle



IN TESTA
anta con maniglia in testa
door with top mounted handle



FUSION
anta con maniglia integrata
door with built-in handle

ANTA SQUADRATA
CON MANIGLIA
SQUARE DOOR WITH HANDLE



BRIDGE

I MODELLI BRIDGE POSSONO ESSERE REALIZZATI ANCHE SENZA MANIGLIA CON DIVERSE TIPOLOGIE DI APERTURE.

BRIDGE MODELS CAN BE REALIZED ALSO WITHOUT HANDLE AND SEVERAL TYPES OF OPENINGS.

PENSILI APERTURA PRESA SU FONDO WALL UNITS WITH GRIP ON BOTTOM OPENING



PARTICOLARE PRESA SU FONDO
DETAIL WITH GRIP ON BOTTOM

ANTA PUSH-PULL PER BASI E COLONNE PUSH-PULL DOOR FOR BASE UNITS AND COLUMNS

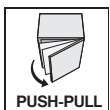

MECCANISMO PUSH-PULL
PUSH-PULL MACHNISM

CASSETTO E CESTONE TIP-ON DRAWER AND DEEP DRAWER TIP-ON



MECCANISMO TIP-ON
TIP-ON MACHNISM

LAVASTOVIGLIE CON SERVO-DRIVE FLEX DISHWASHER WITH FLEX SERVO-DRIVE



MECCANISMO SERVO-DRIVE
SERVO-DRIVE MACHNISM

FRIGO CON SERVO-DRIVE FLEX FRIDGE WITH FLEX SERVO-DRIVE



MECCANISMO SERVO-DRIVE
SERVO-DRIVE MACHNISM

SP. 22 MM**OLTRE** Bridge

N.B.: i prezzi sono espressi all'unità di euro (iva esclusa)

CARATTERISTICHE TECNICHE**ANTE E FRONTALI
CASSETTI**

anta sp.22 mm impiallacciata **rovere vintage con nodi e stuccature venatura verticale finitura materica** nei colori: rovere bianco invecchiato (opz.5380), rovere juta invecchiato (opz.5381), rovere corteccia invecchiato (opz.5382), rovere mielato invecchiato (opz.5383), rovere antracite invecchiato (opz.5384), rovere argilla invecchiato (opz.5385), rovere moro invecchiato (opz.5386), rovere naturale invecchiato parquettato (opz.5387), rovere madera termocotto con finto tarlo (opz.5388)

anta sp.22 mm impiallacciata **rovere effetto pettinato venatura verticale finitura materica** nei colori: rovere gesso (opz.5395), rovere sabbia (opz.5396), rovere lavagna (opz.5397), rovere titanio (opz.5398)

MANIGLIE

di serie: 574 finitura acciaio ossidato brown passo mm 16/160/320 in funzione dell'anta

a richiesta: 491 finitura inox satinato passo mm 96/160/320 in funzione dell'anta
 475M finitura brown opaco passo mm 96/160/320 in funzione dell'anta
 477 finitura cromo passo mm 64/160/320 in funzione dell'anta
 551 finitura cromo passo mm 64/160/320 in funzione dell'anta
 590 finitura nero martellato passo mm 96/192 in funzione dell'anta
 578D finitura old dark passo mm 64/192/320 in funzione dell'anta
 578G finitura old grey passo mm 64/192/320 in funzione dell'anta
 585 finitura acciaio ossidato semioptico passo mm 64/160 in funzione dell'anta
 576 finitura urban passo mm 96/160/320 in funzione dell'anta
 575 finitura ferro passo mm 64/192/320 in funzione dell'anta
 581 incassata finitura bronzo titanio passo mm 64/128
 M40 finitura nero soft passo in funzione dell'anta
 M41 finitura ferro grezzo passo in funzione dell'anta
 M42 finitura nichel satinato passo in funzione dell'anta
 M40V finitura nero soft passo in funzione dell'anta
 M41V finitura ferro grezzo passo in funzione dell'anta
 M42V finitura nichel satinato passo in funzione dell'anta
 FU11 "fusion" finitura nero opaco passo in funzione dell'anta
 FU12 "fusion" finitura titanio passo in funzione dell'anta
 H51 finitura urban applicata in testa lunghezza in funzione dell'anta
 H52 finitura titanio applicata in testa lunghezza in funzione dell'anta

STRUTTURE

ANTE: rovere argilla invecchiato, rovere gesso

di serie : nobilitato bianco (opz.001) schiena e ripiano bianco (opz.001)

ANTE: rovere bianco invecchiato, rovere juta invecchiato, rovere sabbia, rovere titanio

di serie : nobilitato visone (opz.948M) schiena e ripiano visone (opz.948M)

ANTE: rovere antracite invecchiato, rovere lavagna

di serie : nobilitato lavagna (opz.9620) schiena e ripiano lavagna (opz.9620)

ANTE: rovere corteccia invecchiato, rovere mielato invecchiato, rovere moro invecchiato, rovere naturale parquettato, rovere madera termocotto

di serie : nobilitato fango (opz.8860) schiena e ripiano fango (opz.8860)

a richiesta : nobilitato perla d'oriente (opz.940) schiena e ripiano bianco (opz.001)
 nobilitato devalè finitura grafis (opz.796) schiena e ripiano bianco (opz.001)

MENSOLE

di serie: altezza cm 3,8 in laminato come strutture: bianco (opz.001), perla d'oriente (opz.940), devalè grafis (opz.796), visone (opz.948M), lavagna (opz.9620), fango (opz.8860)

a richiesta: altezza cm 3,8 impiallacciata finiture come ante

ZOCCOLI

di serie: zoccolo H 6 in alluminio finitura titanio ossidato (opz.414)

a richiesta: zoccolo H 6 in alluminio finiture urban ossidato (opz.NU), brill (opz.412)

zoccolo H 6 in alluminio verniciato a polvere finitura opaca nei colori: nero (opz.7892), giallo ambra (opz.8225), salvia (opz.8443), rosso toscano (opz.8157), grigio nebbia (opz.9551), bianco assoluto (opz.740S), acquamarina (opz.8323), verde acqua (opz.8473), verde positano (opz.8471), castoro (opz.8907), verde lichene (opz.8463), grigio bromo (opz.9533), fumo (opz.9531), bianco caldo (opz.7401), rosa quarzo (opz.8171), blu cadetto (opz.8373),



TH. 22 MM

OLTRE Bridge

Note: the prices are expressed in units of Euro (vat not included)

TECHNICAL FEATURES**DOORS AND
DRAWER FRONTS**

22 mm th. veneered door **vintage oak with knots and filler vertical grain textured finish** in the following colours: white aged oak (opt.5380), jute aged oak (opt.5381), bark aged oak (opt.5382), honey aged oak (opt.5383), anthracite aged oak (opt.5384), clay aged oak (opt.5385), dark aged oak (opt.5386), parquet-effect natural aged oak (opt.5387) heat treated madera oak with worm-eaten effect (opt.5388)

22 mm th. veneered door **combed-effect oak vertical grain textured finish** in the following colours: chalk oak (opt.5395), sand oak (opt.5396), slate grey oak (opt.5397), titanium oak (opt.5398)

HANDLES

standard: 574 brown oxidized steel finish, 16/160/320 centre-to-centre distance depending to the door measure

on request: 491 stainless steel satin finish, 96/160/320 centre-to-centre distance depending to the door measure
 475M matt brown finish, 96/160/320 centre-to-centre distance depending to the door measure
 477 chrome finish, 64/160/320 centre-to-centre distance depending to the door measure
 551 chrome finish, 64/160/320 centre-to-centre distance depending to the door measure
 590 hammered black finish, 96/192 centre-to-centre distance depending to the door measure
 578D old dark finish, 64/192/320 centre-to-centre distance depending to the door measure
 578G old grey finish, 64/192/320 centre-to-centre distance depending to the door measure
 585 half-matt oxidized steel finish, 64/160 centre-to-centre distance depending to the door measure
 576 urban finish, 96/160/320 centre-to-centre distance depending to the door measure
 575 iron finish, 64/192/320 centre-to-centre distance depending to the door measure
 581 built-in bronze titanium finish, 64/128 centre-to-centre distance
 M40 soft black finish, centre-to-centre distance depending to the door measure
 M41 unrefined iron finish, centre-to-centre distance depending to the door measure
 M42 nickel satin finish, centre-to-centre distance depending to the door measure
 M40V soft black finish, centre-to-centre distance depending to the door measure
 M41V unrefined iron finish, centre-to-centre distance depending to the door measure
 M42V nickel satin finish, centre-to-centre distance depending to the door measure
 FU11 "fusion" matt black finish, centre-to-centre distance depending to the door measure
 FU12 "fusion" titanium finish, centre-to-centre distance depending to the door measure
 H51 urban finish, applied on top lenght depending on door
 H52 titanium finish, applied on top lenght depending on door

STRUCTURES

DOORS: clay aged oak, chalk oak

standard: melamine-coated white (opt.001), white back panel and shelf (opt.001)

DOORS: white aged oak, jute aged oak, sand oak, titanium oak

standard: melamine-coated mink (opt.948M), mink back panel and shelf (opt.948M)

DOORS: anthracite aged oak, slate grey oak

standard: melamine-coated slate grey (opt.9620), slate grey back panel and shelf (opt.9620)

DOORS: bark aged oak, honey aged oak, dark aged oak, parquet-effect natural aged oak, heat treated madera oak

standard: melamine-coated mud (opt.8860), mud back panel and shelf (opt.8860)

on request: melamine-coated oriental pearl (opt.940), white back panel and shelf (opt.001)

melamine-coated devalè with grafis finish (opt.796), white back panel and shelf (opt.001)

SHELVES

standard: height 3.8 cm, in laminate to match structure: white (opt.001), oriental pearl (opt.940), devalè grafis (opt.796), mink (opt.948M), slate grey (opt.9620), mud (opt.8860)

on request: height 3.8 cm, veneered to match doors

PLINTHS

standard: plinth H 6 cm, in aluminium with oxidised titanium (opt.414) finish

on request: plinth H 6 cm in aluminium with oxidised urban (opt.NU), brill (opt.412) finishes

plinth H 6 cm in aluminium with matt powder coating in the following colours: black (opt.7892), amber yellow (opt.8225), sage (opt.8443), tuscan red (opt.8157), mist grey (opt.9551), absolute white (opt.740S), aquamarine (opt.8323), water green (opt.8473), positano green (opt.8471), beaver (opt.8907), lichen green (opt.8463), bromine grey (opt.9533), smoke (opt.9531), warm white (opt.7401), rose quartz (opt.8171), cadet blue (opt.8373),

cod. **280**

Impiallacciato Veneered

OLTRE **B**ridge

SP. 22 MM TH. 22 MM

anta finitura materica vintage
door with textured vintage finish



rovere bianco invecchiato
(opz.5380)
white aged oak (opt.5380)



rovere juta invecchiato
(opz.5381)
jute aged oak (opt.5381)



rovere corteccia invecchiato
(opz.5382)
bark aged oak (opt.5382)



rovere mielato invecchiato
(opz.5383)
honey aged oak (opt.5383)



rovere antracite invecchiato
(opz.5384)
anthracite aged oak
(opt.5384)



rovere argilla invecchiato
(opz.5385)
clay aged oak (opt.5385)



rovere moro invecchiato
(opz.5386)
dark aged oak (opt.5386)



rovere naturale invecchiato
parquettato (opz.5387)
parquet-effect natural aged
oak (opt.5387)



rovere maderia termocotto
con finto tarlo (opz.5388)
heat treated maderia oak with
worm-eaten effect (opt.5388)



particolare anta con finto tarlo
door with worm-eaten effect detail

cod. **280**

Impiallacciato Veneered

SP. 22 MM TH. 22 MM

OLTRE Bridge

anta finitura materica effetto pettinato
door with combed-effect textured finish



rovere gesso (opz.5395)
chalk oak (opt.5395)



rovere sabbia (opz.5396)
sand oak (opt.5396)



rovere lavagna (opz.5397)
slate grey oak (opt.5397)



rovere titanio (opz.5398)
titanium oak (opt.5398)



BRIDGE

SP. 22 MM**OLTRE** Bridge

N.B.: i prezzi sono espressi all'unità di euro (iva esclusa)

CARATTERISTICHE TECNICHE**ANTE E FRONTALI
CASSETTI**

anta sp.22 mm con pannello in truciolare E1 rivestito lato esterno con fenix spessore 9/10 lato interno in laminato spessore 9/10 in tinta come esterno, bordata in polipropilene con incollaggio laser spessore 10/10, nei colori: bianco caldo (opz.7446), castoro (opz.8864), nero (opz.7861), grigio bromo (opz.9628), fumo (opz.9629)

MANIGLIE

di serie: 574 finitura acciaio ossidato brown passo mm 16/160/320 in funzione dell'anta

a richiesta: 491 finitura inox satinato passo mm 96/160/320 in funzione dell'anta
 475M finitura brown opaco passo mm 96/160/320 in funzione dell'anta
 477 finitura cromo passo mm 64/160/320 in funzione dell'anta
 551 finitura cromo passo mm 64/160/320 in funzione dell'anta
 590 finitura nero martellato passo mm 96/192 in funzione dell'anta
 578D finitura old dark passo mm 64/192/320 in funzione dell'anta
 578G finitura old grey passo mm 64/192/320 in funzione dell'anta
 585 finitura acciaio ossidato semiopaco passo mm 64/160 in funzione dell'anta
 576 finitura urban passo mm 96/160/320 in funzione dell'anta
 575 finitura ferro passo mm 64/192/320 in funzione dell'anta
 581 incassata finitura bronzo titanio passo mm 64/128
 M40 finitura nero soft passo in funzione dell'anta
 M41 finitura ferro grezzo passo in funzione dell'anta
 M42 finitura nichel satinato passo in funzione dell'anta
 M40V finitura nero soft passo in funzione dell'anta
 M41V finitura ferro grezzo passo in funzione dell'anta
 M42V finitura nichel satinato passo in funzione dell'anta
 FU11 "fusion" finitura nero opaco passo in funzione dell'anta
 FU12 "fusion" finitura titanio passo in funzione dell'anta
 H51 finitura urban applicata in testa lunghezza in funzione dell'anta
 H52 finitura titanio applicata in testa lunghezza in funzione dell'anta

STRUTTURE**ANTA: bianco caldo**

di serie : nobilitato bianco (opz.001) schiena e ripiano bianco (opz.001)

ANTA: fumo

di serie : nobilitato visone (opz.948M) schiena e ripiano visone (opz.948M)

ANTE: nero, grigio bromo

di serie : nobilitato lavagna (opz.9620) schiena e ripiano lavagna (opz.9620)

ANTA: castoro

di serie : nobilitato devalè finitura grafis (opz.796) schiena e ripiano bianco (opz.001)

a richiesta : nobilitato perla d'oriente (opz.940) schiena e ripiano bianco (opz.001)
 nobilitato fango (opz.8860) schiena e ripiano fango (opz.8860)

**MENSOLE**

di serie: altezza cm 3,8 in laminato come strutture: bianco (opz.001), perla d'oriente (opz.940), devalè grafis (opz.796), visone (opz.948M), lavagna (opz.9620), fango (opz.8860)

a richiesta: altezza cm 3,8 finiture come ante

ZOCCOLI

di serie: zoccolo H 6 in alluminio finitura titanio ossidato (opz.414)

a richiesta: zoccolo H 6 in alluminio finiture urban ossidato (opz.NU), brill (opz.412)

zoccolo H 6 in alluminio verniciato a polvere finitura opaca nei colori: nero (opz.7892), giallo ambra (opz.8225), salvia (opz.8443), rosso toscano (opz.8157), grigio nebbia (opz.9551), bianco assoluto (opz.740S), acquamarina (opz.8323), verde acqua (opz.8473), verde positano (opz.8471), castoro (opz.8907), verde lichene (opz.8463), grigio bromo (opz.9533), fumo (opz.9531), bianco caldo (opz.7401), rosa quarzo (opz.8171), blu cadetto (opz.8373),



TH. 22 MM

OLTRE Bridge

Note: the prices are expressed in units of Euro (vat not included)

TECHNICAL FEATURES**DOORS AND
DRAWER FRONTS**

22 mm th. door with E1 chipboard panel with exterior coated in 9/10 thickness Fenix and interior in 9/10 thickness laminate in the same colour as the exterior. Edge in 10/10 thickness polypropylene with laser gluing, in the following colours: warm white (opt.7446), beaver (opt.8864), black (opt.7861), bromine grey (opt.9628), smoke (opt.9629)

HANDLES

standard: 574 brown oxidized steel finish, 16/160/320 centre-to-centre distance depending to the door measure

on request: 491 stainless steel satin finish, 96/160/320 centre-to-centre distance depending to the door measure
 475M matt brown finish, 96/160/320 centre-to-centre distance depending to the door measure
 477 chrome finish, 64/160/320 centre-to-centre distance depending to the door measure
 551 chrome finish, 64/160/320 centre-to-centre distance depending to the door measure
 590 hammered black finish, 96/192 centre-to-centre distance depending to the door measure
 578D old dark finish, 64/192/320 centre-to-centre distance depending to the door measure
 578G old grey finish, 64/192/320 centre-to-centre distance depending to the door measure
 585 half-matt oxidized steel finish, 64/160 centre-to-centre distance depending to the door measure
 576 urban finish, 96/160/320 centre-to-centre distance depending to the door measure
 575 iron finish, 64/192/320 centre-to-centre distance depending to the door measure
 581 built-in bronze titanium finish, 64/128 centre-to-centre distance
 M40 soft black finish, centre-to-centre distance depending to the door measure
 M41 unrefined iron finish, centre-to-centre distance depending to the door measure
 M42 nickel satin finish, centre-to-centre distance depending to the door measure
 M40V soft black finish, centre-to-centre distance depending to the door measure
 M41V unrefined iron finish, centre-to-centre distance depending to the door measure
 M42V nickel satin finish, centre-to-centre distance depending to the door measure
 FU11 "fusion" matt black finish, centre-to-centre distance depending to the door measure
 FU12 "fusion" titanium finish, centre-to-centre distance depending to the door measure
 H51 urban finish, applied on top lenght depending on door
 H52 titanium finish, applied on top lenght depending on door

STRUCTURES

DOOR: warm white
standard: melamine-coated white (opt.001), white back panel and shelf (opt.001)
DOOR: smoke
standard: melamine-coated mink (opt.948M), mink back panel and shelf (opt.948M)
DOORS: black, bromine grey
standard: melamine-coated slate grey (opt.9620), slate grey back panel and shelf (opt.9620)
DOOR: beaver
standard: melamine-coated devalè with grafis finish (opt.796), white back panel and shelf (opt.001)
on request: melamine-coated oriental pearl (opt.940), white back panel and shelf (opt.001)
 melamine-coated mud (opt.8860), mud back panel and shelf (opt.8860)

SHELVES

standard: height 3.8 cm, in laminate to match structure: white (opt.001) oriental pearl (opt.940) devalè grafis (opt.796), mink (opt.948M), slate grey (opt.9620), mud (opt.8860)
on request: height 3.8 cm, finished to match doors

PLINTHS

standard: plinth H 6 cm, in aluminium with oxidised titanium (opt.414) finish
on request: plinth H 6 cm in aluminium with oxidised urban (opt.NU), brill (opt.412) finishes
 plinth H 6 cm in aluminium with matt powder coating in the following colours: black (opt.7892), amber yellow (opt.8225), sage (opt.8443), tuscan red (opt.8157), mist grey (opt.9551), absolute white (opt.740S), aquamarine (opt.8323), water green (opt.8473), positano green (opt.8471), beaver (opt.8907), lichen green (opt.8463), bromine grey (opt.9533), smoke (opt.9531), warm white (opt.7401), rose quartz (opt.8171), cadet blue (opt.8373),

SP. 22 MM TH. 22 MM**OLTRE** Bridge

anta finitura fenix

door with fenix finish

bianco caldo (opz.7446)
warm white (opt.7446)castoro (opz.8864)
beaver (opt.8864)nero (opz.7861)
black (opt.7861)grigio bromo (opz.9628)
bromine grey (opt.9628)fumo (opz.9629)
smoke (opt.9629)

Informazioni tecniche

FENIX NTM™

È un nuovissimo prodotto per l'interior design sviluppato da Arpa Industriale.

Prodotto grazie a resine di nuova generazione, questo materiale intelligente si contraddistingue per una superficie dalle proprietà straordinarie.

Con una bassa riflessione della luce, la sua superficie è estremamente opaca (valore di riflessione speculare: 1,5 e 60°) e anti impronte digitali.

Grazie all'utilizzo della nanotecnologia, eventuali micrograffi possono essere riparati termicamente ed è inoltre piacevolmente soft touch.

FENIX NTM™ è Made in Italy.

FENIX NTM™ è un materiale innovativo di Arpa Industriale creato per l'interior design prodotto mediante l'applicazione simultanea di calore (circa 150°C) e alta pressione specifica (> 7 MPa) per ottenere un prodotto omogeneo non poroso con densità elevata.

Il suo core è composto da carta impregnata in resina termoindurente mentre la superficie decorativa, ottenuta con l'ausilio di nanotecnologie, è costituita da una carta decorativa trattata con resine di nuova generazione frutto della ricerca di Arpa Industriale.

FENIX NTM™ è un materiale che si distingue per particolari caratteristiche quali: alta resistenza al graffio e al calore, anti impronta, morbidezza al tatto, bassa riflessione della luce, riparabilità termica dei micrograffi, alta attività di abbattimento della carica batterica.

FENIX NTM™ è un marchio registrato da Arpa Industriale.

FENIX NTM™ è placcato su truciolare idrorepellente e il top è bordato sui lati a vista con polipropilene spessore 1 mm in tinta.

Technical information

FENIX NTM™

It is a brand new interior design product developed by Arpa Industriale.

Using the most modern resins, this intelligent material stands out for the extraordinary characteristics of its surface.

The matt surface has an exceptionally low reflectivity (specular reflection index: 1.5 and 60°) and is highly resistant to hand and finger prints.

The material uses nanotechnology to enable micro-scratches to be healed thermally, and it also has a very pleasant soft touch effect.

FENIX NTM™ is Made in Italy.

FENIX NTM™ is an innovative interior design product from Arpa Industriale, made by applying heat (around 150°C) and high pressure (> 7 MPa) to obtain a non-porous very dense material.

Its core is composed of paper impregnated with thermosetting resin, while the surface, which employs nanotechnology processes, is composed of a decorative paper treated with the most recently developed resins from the Arpa Industriale research labs.

FENIX NTM™ stands out for its exceptional resistance to scratching, heat and hand and finger prints, soft touch, low reflectivity, thermal healing of micro-scratches, and effective anti-bacterial action.

FENIX NTM™ is a registered trademark of Arpa Industriale.

FENIX NTM™ is fixed on waterproof fiberboard and the top is trimmed on visible sides with 1 mm polypropylene in matching colour.

FENIX NTM™



Resistenza ai graffi e all'abrasione
Resistance to scratches and abrasion



Alta attività di abbattimento della carica batterica
Enhanced anti-bacterial properties



Igienico
Hygienic



Idoneo al contatto con gli alimenti
Suitable for contact with food



Facile da pulire
Easy to clean



Antimuffa
Mold-resistant



Antistatico
Antistatic



Idrorepellente
Water proof



Bassa riflessione della luce, superficie estremamente opaca
Low light reflection, extremely matt surface



Anti-impronta
Anti-huella digital



Stabilità dimensionale in presenza di elevata variazione termica
Dimensional stability even at high temperature changes



Resistenza all'urto
Resistance to impact



Stabilità alla luce
Lightfastness



Resistenza al calore secco
Resistance to dry heat



Eccellente intensità e profondità del colore
Excellent intensity and colour depth



Resistenza allo strofinamento
Rub resistance



Elevata resistenza a solventi acidi e ai reagenti di uso domestico
High resistance to acid solvents and household reagents



Autoportante (solo per gli spessori 10 e 12 mm)
Self-supporting (only for 10 and 12 mm)



Riparabilità termica dei micrograffi
Repairability thermal micro-scratches



Morbidezza al tatto
Soft to the touch

FENIX NTM™

RIPARABILITÀ TERMICA DEI MICROGRAFFI
Nanotech matt material for interior design



ISTRUZIONI PER LA MANUTENZIONE.
MAINTENANCE

FERRO DA STIRO.
CLOTHES IRON

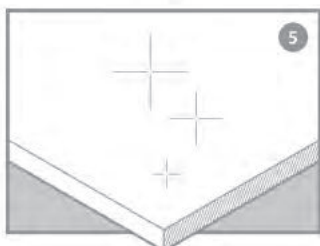
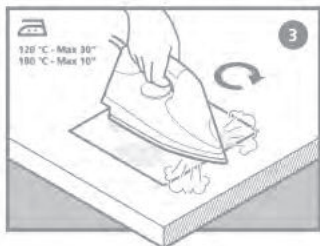
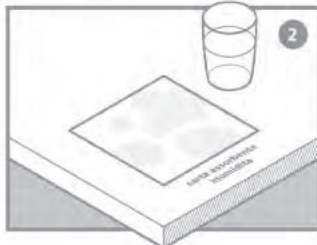
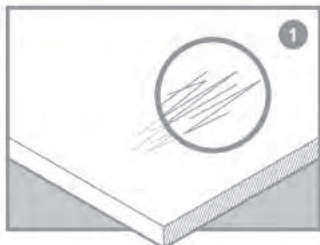

ISTRUZIONI PER LA MANUTENZIONE.
MAINTENANCE

SPUGNA DI SCHIUMA MELAMMINICA.
MELAMINE FOAM SPONGE

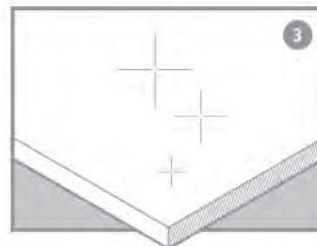
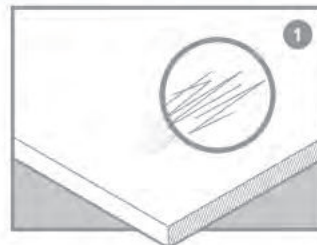

Visiti fenixntm.com
go to fenixntm.com

per scoprire tutte le proprietà
for further details

made in Italy by Arpa Industriale

SP. 22 MM**OLTRE** Bridge

N.B.: i prezzi sono espressi all'unità di euro (iva esclusa)

CARATTERISTICHE TECNICHE**ANTE E FRONTALI
CASSETTI**

anta sp.22 mm composta da un supporto in agglomerato di legno rivestito su due lati con pannelli in HDF classe E1, ricoperto in malta cementizia nei colori: old white (opz.MA11), old grey (opz.MA12), old dark (opz.MA13), old black (opz.MA14)

MANIGLIE

di serie: 574 finitura acciaio ossidato brown passo mm 16/160/320 in funzione dell'anta

a richiesta: 578D finitura old dark passo mm 64/192/320 in funzione dell'anta
 578G finitura old grey passo mm 64/192/320 in funzione dell'anta
 491 finitura inox satinato passo mm 96/160/320 in funzione dell'anta
 475M finitura brown opaco passo mm 96/160/320 in funzione dell'anta
 477 finitura cromo passo mm 64/160/320 in funzione dell'anta
 551 finitura cromo passo mm 64/160/320 in funzione dell'anta
 590 finitura nero martellato passo mm 96/192 in funzione dell'anta
 585 finitura acciaio ossidato semiopaco passo mm 64/160 in funzione dell'anta
 576 finitura urban passo mm 96/160/320 in funzione dell'anta
 575 finitura ferro passo mm 64/192/320 in funzione dell'anta
 581 incassata finitura bronzo titanio passo mm 64/128
 M40 finitura nero soft passo in funzione dell'anta
 M41 finitura ferro grezzo passo in funzione dell'anta
 M42 finitura nichel satinato passo in funzione dell'anta
 M40V finitura nero soft passo in funzione dell'anta
 M41V finitura ferro grezzo passo in funzione dell'anta
 M42V finitura nichel satinato passo in funzione dell'anta
 FU11 "fusion" finitura nero opaco passo in funzione dell'anta
 FU12 "fusion" finitura titanio passo in funzione dell'anta
 H51 finitura urban applicata in testa lunghezza in funzione dell'anta
 H52 finitura titanio applicata in testa lunghezza in funzione dell'anta

STRUTTURE

ANTA: old white
 di serie : nobilitato devalè finitura grafis (opz.796) schiena e ripiano bianco (opz.001)
ANTA: old grey, old black
 di serie : nobilitato lavagna (opz.9620) schiena e ripiano lavagna (opz.9620)
ANTA: old dark
 di serie : nobilitato fango (opz.8860) schiena e ripiano fango (opz.8860)

a richiesta : nobilitato perla d'oriente (opz.940) schiena e ripiano bianco (opz.001)
 nobilitato bianco (opz.001) schiena e ripiano bianco (opz.001)
 nobilitato visone (opz.948M) schiena e ripiano visone (opz.948M)

**MENSOLE**

di serie: altezza cm 3,8 in laminato come strutture: bianco (opz.001), perla d'oriente (opz.940), devalè grafis (opz.796), visone (opz.948M), lavagna (opz.9620), fango (opz.8860)

a richiesta: altezza cm 3,8 finiture come ante

ZOCCOLI

di serie: zoccolo H 6 in alluminio finitura titanio ossidato (opz.414)

a richiesta: zoccolo H 6 in alluminio finiture urban ossidato (opz.NU), brill (opz.412)

zoccolo H 6 in alluminio verniciato a polvere finitura opaca nei colori: nero (opz.7892), giallo ambra (opz.8225), salvia (opz.8443), rosso toscano (opz.8157), grigio nebbia (opz.9551), bianco assoluto (opz.740S), acquamarina (opz.8323), verde acqua (opz.8473), verde positano (opz.8471), castoro (opz.8907), verde lichene (opz.8463), grigio bromo (opz.9533), fumo (opz.9531), bianco caldo (opz.7401), rosa quarzo (opz.8171), blu cadetto (opz.8373),



TH. 22 MM

OLTRE **B**ridge

Note: the prices are expressed in units of Euro (vat not included)

TECHNICAL FEATURES

DOORS AND DRAWER FRONTS

22 mm th. door comprised of a support in wood composite covered on two sides with class E1 HDF panels, covered in cement mortar in the following colours: old white (opt.MA11), old grey (opt.MA12), old dark (opt.MA13), old black (opt.MA14)

HANDLES

standard: 574 brown oxidized steel finish, 16/160/320 centre-to-centre distance depending to the door measure

on request: 578D old dark finish, 64/192/320 centre-to-centre distance depending to the door measure
 578G old grey finish, 64/192/320 centre-to-centre distance depending to the door measure
 491 stainless steel satin finish, 96/160/320 centre-to-centre distance depending to the door measure
 475M matt brown finish, 96/160/320 centre-to-centre distance depending to the door measure
 477 chrome finish, 64/160/320 centre-to-centre distance depending to the door measure
 551 chrome finish, 64/160/320 centre-to-centre distance depending to the door measure
 590 hammered black finish, 96/192 centre-to-centre distance depending to the door measure
 585 half-matt oxidized steel finish, 64/160 centre-to-centre distance depending to the door measure
 576 urban finish, 96/160/320 centre-to-centre distance depending to the door measure
 575 iron finish, 64/192/320 centre-to-centre distance depending to the door measure
 581 built-in bronze titanium finish, 64/128 centre-to-centre distance
 M40 soft black finish, centre-to-centre distance depending to the door measure
 M41 unrefined iron finish, centre-to-centre distance depending to the door measure
 M42 nickel satin finish, centre-to-centre distance depending to the door measure
 M40V soft black finish, centre-to-centre distance depending to the door measure
 M41V unrefined iron finish, centre-to-centre distance depending to the door measure
 M42V nickel satin finish, centre-to-centre distance depending to the door measure
 FU11 "fusion" matt black finish, centre-to-centre distance depending to the door measure
 FU12 "fusion" titanium finish, centre-to-centre distance depending to the door measure
 H51 urban finish, applied on top lenght depending on door
 H52 titanium finish, applied on top lenght depending on door

STRUCTURES

DOOR: old white
standard: melamine-coated devalè with grafis finish (opt.796), white back panel and shelf (opt.001)
DOORS: old grey, old black
standard: melamine-coated slate grey (opt.9620), slate grey back panel and shelf (opt.9620)
DOOR: old dark
standard: melamine-coated mud (opt.8860), mud back panel and shelf (opt.8860)

on request: melamine-coated oriental pearl (opt.940), white back panel and shelf (opt.001)
 melamine-coated white (opt.001), white back panel and shelf (opt.001)
 melamine-coated mink (opt.948M), mink back panel and shelf (opt.948M)

SHELVES

standard: : height 3.8 cm, in laminate to match structure: white (opt.001) oriental pearl (opt.940) devalè grafis (opt.796), mink (opt.948M), slate grey (opt.9620), mud (opt.8860)

on request: height 3.8 cm, finished to match doors

PLINTHS

standard: plinth H 6 cm, in aluminium with oxidised titanium (opt.414) finish

on request: plinth H 6 cm in aluminium with oxidised urban (opt.NU), brill (opt.412) finishes
 plinth H 6 cm in aluminium with matt powder coating in the following colours: black (opt.7892), amber yellow (opt.8225), sage (opt.8443), tuscan red (opt.8157), mist grey (opt.9551), absolute white (opt.740S), aquamarine (opt.8323), water green (opt.8473), positano green (opt.8471), beaver (opt.8907), lichen green (opt.8463), bromine grey (opt.9533), smoke (opt.9531), warm white (opt.7401), rose quartz (opt.8171), cadet blue (opt.8373),

SP. 22 MM TH. 22 MM

OLTRE **B**ridge

anta finitura malta

door with mortar finish



old white (opz.MA11)



old grey (opz.MA12)



old dark (opz.MA13)



old black (opz.MA14)

Informazioni tecniche

La malta cementizia è realizzata con impasti derivati da miscele, attentamente studiate, di leganti idraulici ed inerti, a base di farine di quarzo e sabbie minerali a granulometria controllata, esente da sali ed impurezze. A questo formulato viene aggiunta una percentuale (1÷2%) di polimeri elastomerici stabilizzanti, per evitare tensioni o crepe generate da sbalzi di temperatura e sollecitazioni dinamiche particolari. Prima dell'applicazione le superfici vengono trattate per poter permettere l'applicazione del rasante. Quest'ultimo viene applicato rigorosamente a mano da esperti artigiani su pannelli compositi. Sulla superficie, una volta asciutta, vengono applicate più mani di rivestimento acrilico trasparente: questo trattamento protegge la superficie da infiltrazioni di unto e sporco.

La particolarità del prodotto e soprattutto il modo di applicazione, ne determinano un aspetto cementizio con alcune caratteristiche proprie della sua natura, quali piccole imperfezioni, piccoli fori ed angoli non perfettamente squadrati e segni disomogenei della spatola, che esaltano la lavorazione artigianale.

Uso e manutenzione

La collezione è caratterizzata da un'adeguata resistenza alle abrasioni, ai graffi e alle possibili macchie. È comunque molto importante un corretto trattamento e una corretta manutenzione del prodotto.

Per quanto concerne la pulizia delle superfici è indicato l'uso di detersivi neutri diluiti in acqua tiepida (proporzione 1:10, ad esempio 0,1 L di prodotto pulente e 1 L di acqua) e passati con dei semplici panni in microfibra. È consigliato risciacquare i detersivi usati, in quanto si riduce notevolmente il rischio di usura dello strato di rivestimento a protezione della superficie. È altamente sconsigliato l'utilizzo di prodotti concentrati e di sistemi di pulizia a vapore.

Technical Information

Cement mortar is made from pastes derived from carefully blended mixtures of inert hydraulic bonding agents, comprised of quartz and mineral sands with controlled granule sizes free from salts and impurities. This formula is then blended with a percentage (1-2%) of stabilising elastomeric polymers to prevent tensions and cracks caused by temperature changes and dynamic stresses. The surfaces are treated before application to allow the coating to adhere. The coating is then applied by hand by expert craftsmen onto the composite panels. Once dry, the surface is then treated with a transparent acrylic coating; this treatment protects the surface against grease and dirt.

The special qualities of the product, and in particular the application method, create a cement effect that has certain inherent properties, such as small imperfections, tiny holes, and corners that aren't perfectly square. There may also be uneven trowel marks, all of which highlight the craft manufacture.

Use and maintenance

This collection is characterised by good resistance to abrasion, scratches and stains.

It is nonetheless very important to treat and maintain the product correctly.

With regards to cleaning surfaces, we recommend the use of neutral detergents diluted in tepid water (dilution 1:10, e.g. 0.1 L of cleaning product in 1 L of water) applied using a micro-fibre cloth.

We recommend rinsing off any detergents used as this considerably reduces the wear on the coating protecting the surface. The use of concentrated cleaning products and steam cleaning systems should be strictly avoided.

sezione anta
door section

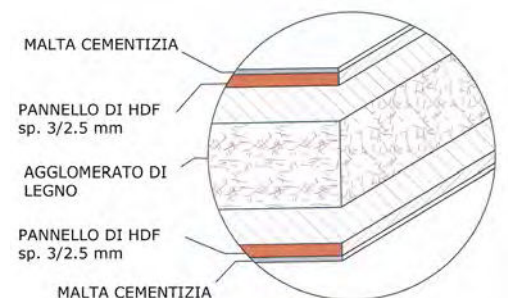

Maniglie abbinabili alle finiture malta

Handles to match with mortar
finishes



Maniglia 578D finitura old dark
Handle 578D old dark finish



Maniglia 578G finitura old grey
Handle 578G old grey finish



old white (opz.MA11)



old dark (opz.MA13)



old grey (opz.MA12)



old black (opz.MA14)



SP. 22 MM**OLTRE** Bridge

N.B.: i prezzi sono espressi all'unità di euro (iva esclusa)

CARATTERISTICHE TECNICHE**ANTE E FRONTALI
CASSETTI**

anta sp.22 mm in mdf laccata **finitura opaca testurizzata soft nei colori freddi**: bianco assoluto (opz.740S), cenere (opz.9547), argilla (opz.9503), grigio bromo (opz.9533), nero (opz.7892), blu notte (opz.8375), blu fiordaliso (opz.8377)

anta sp.22 mm in mdf laccata **finitura opaca testurizzata soft nei colori caldi**: bianco caldo (opz.7401), canapa (opz.8531), grigio kenya (opz.9501), castoro (opz.8907), fumo (opz.9531), grigio piombo (opz.9537), bistro (opz.9535), verde lichene (opz.8463), verde positano (opz.8471), giallo ambra (opz.327S), rosso toscano (opz.8157), terra di siena (opz.8161)

MANIGLIE

di serie: 574 finitura acciaio ossidato brown passo mm 16/160/320 in funzione dell'anta

a richiesta: 491 finitura inox satinato passo mm 96/160/320 in funzione dell'anta
 475M finitura brown opaco passo mm 96/160/320 in funzione dell'anta
 477 finitura cromo passo mm 64/160/320 in funzione dell'anta
 551 finitura cromo passo mm 64/160/320 in funzione dell'anta
 590 finitura nero martellato passo mm 96/192 in funzione dell'anta
 578D finitura old dark passo mm 64/192/320 in funzione dell'anta
 578G finitura old grey passo mm 64/192/320 in funzione dell'anta
 585 finitura acciaio ossidato semiopaco passo mm 64/160 in funzione dell'anta
 576 finitura urban passo mm 96/160/320 in funzione dell'anta
 575 finitura ferro passo mm 64/192/320 in funzione dell'anta
 581 incassata finitura bronzo titanio passo mm 64/128
 M40 finitura nero soft passo in funzione dell'anta
 M41 finitura ferro grezzo passo in funzione dell'anta
 M42 finitura nichel satinato passo in funzione dell'anta
 M40V finitura nero soft passo in funzione dell'anta
 M41V finitura ferro grezzo passo in funzione dell'anta
 M42V finitura nichel satinato passo in funzione dell'anta
 FU11 "fusion" finitura nero opaco passo in funzione dell'anta
 FU12 "fusion" finitura titanio passo in funzione dell'anta
 H51 finitura urban applicata in testa lunghezza in funzione dell'anta
 H52 finitura titanio applicata in testa lunghezza in funzione dell'anta

STRUTTURE

di serie: nobilitato bianco (opz.001) schiena e ripiano bianco (opz.001)

a richiesta: nobilitato visone (opz.948M) schiena e ripiano visone (opz.948M)
 nobilitato lavagna (opz.9620) schiena e ripiano lavagna (opz.9620)
 nobilitato devalè finitura grafis (opz.796) schiena e ripiano bianco (opz.001)
 nobilitato perla d'oriente (opz.940) schiena e ripiano bianco (opz.001)
 nobilitato fango (opz.8860) schiena e ripiano fango (opz.8860)

**MENSOLE**

di serie: altezza cm 3,8 in laminato come strutture: bianco (opz.001), perla d'oriente (opz.940), devalè grafis (opz.796), visone (opz.948M), lavagna (opz.9620), fango (opz.8860)

a richiesta: altezza cm 3,8 laccate opache finitura come anta

ZOCCOLI

di serie: zoccolo H 6 in alluminio finitura titanio ossidato (opz.414)

a richiesta: zoccolo H 6 in alluminio finiture urban ossidato (opz.NU), brill (opz.412)

zoccolo H 6 in alluminio verniciato a polvere finitura opaca nei colori: nero (opz.7892), giallo ambra (opz.8225), salvia (opz.8443), rosso toscano (opz.8157), grigio nebbia (opz.9551), bianco assoluto (opz.740S), acquamarina (opz.8323), verde acqua (opz.8473), verde positano (opz.8471), castoro (opz.8907), verde lichene (opz.8463), grigio bromo (opz.9533), fumo (opz.9531), bianco caldo (opz.7401), rosa quarzo (opz.8171), blu cadetto (opz.8373),



N.B.: i prezzi sono espressi all'unità di euro (iva esclusa)

CARATTERISTICHE TECNICHE**ANTE E FRONTALI
CASSETTI**

anta sp.22 mm in mdf laccata **finitura lucida spazzolata nei colori freddi**: bianco assoluto (opz.741), cenere (opz.9548), argilla (opz.9504), grigio bromo (opz.9534), nero (opz.7893), blu notte (opz.8376), blu fiordaliso (opz.8378)

anta sp.22 mm in mdf laccata **finitura lucida spazzolata nei colori caldi**: bianco caldo (opz.7402), canapa (opz.8532), grigio kenya (opz.9502), castoro (opz.8908), fumo (opz.9532), grigio piombo (opz.9538), bistro (opz.9536), verde lichene (opz.8464), verde positano (opz.8472), giallo ambra (opz.328), rosso toscano (opz.8158), terra di siena (opz.8162)

MANIGLIE

di serie: 574 finitura acciaio ossidato brown passo mm 16/160/320 in funzione dell'anta

a richiesta: 491 finitura inox satinato passo mm 96/160/320 in funzione dell'anta
 475M finitura brown opaco passo mm 96/160/320 in funzione dell'anta
 477 finitura cromo passo mm 64/160/320 in funzione dell'anta
 551 finitura cromo passo mm 64/160/320 in funzione dell'anta
 590 finitura nero martellato passo mm 96/192 in funzione dell'anta
 578D finitura old dark passo mm 64/192/320 in funzione dell'anta
 578G finitura old grey passo mm 64/192/320 in funzione dell'anta
 585 finitura acciaio ossidato semiopaco passo mm 64/160 in funzione dell'anta
 576 finitura urban passo mm 96/160/320 in funzione dell'anta
 575 finitura ferro passo mm 64/192/320 in funzione dell'anta
 581 incassata finitura bronzo titanio passo mm 64/128
 M40 finitura nero soft passo in funzione dell'anta
 M41 finitura ferro grezzo passo in funzione dell'anta
 M42 finitura nichel satinato passo in funzione dell'anta
 M40V finitura nero soft passo in funzione dell'anta
 M41V finitura ferro grezzo passo in funzione dell'anta
 M42V finitura nichel satinato passo in funzione dell'anta
 FU11 "fusion" finitura nero opaco passo in funzione dell'anta
 FU12 "fusion" finitura titanio passo in funzione dell'anta
 H51 finitura urban applicata in testa lunghezza in funzione dell'anta
 H52 finitura titanio applicata in testa lunghezza in funzione dell'anta

STRUTTURE

di serie: nobilitato bianco (opz.001) schiena e ripiano bianco (opz.001)

a richiesta: nobilitato visone (opz.948M) schiena e ripiano visone (opz.948M)
 nobilitato lavagna (opz.9620) schiena e ripiano lavagna (opz.9620)
 nobilitato devalè finitura grafis (opz.796) schiena e ripiano bianco (opz.001)
 nobilitato perla d'oriente (opz.940) schiena e ripiano bianco (opz.001)
 nobilitato fango (opz.8860) schiena e ripiano fango (opz.8860)

**MENSOLE**

di serie: altezza cm 3,8 in laminato come strutture: bianco (opz.001), perla d'oriente (opz.940), devalè grafis (opz.796), visone (opz.948M), lavagna (opz.9620), fango (opz.8860)

a richiesta: altezza cm 3,8 laccate lucide finitura come anta

ZOCCOLI

di serie: zoccolo H 6 in alluminio finitura titanio ossidato (opz.414)

a richiesta: zoccolo H 6 in alluminio finiture urban ossidato (opz.NU), brill (opz.412)

zoccolo H 6 in alluminio verniciato a polvere finitura opaca nei colori: nero (opz.7892), giallo ambra (opz.8225), salvia (opz.8443), rosso toscano (opz.8157), grigio nebbia (opz.9551), bianco assoluto (opz.740S), acquamarina (opz.8323), verde acqua (opz.8473), verde positano (opz.8471), castoro (opz.8907), verde lichene (opz.8463), grigio bromo (opz.9533), fumo (opz.9531), bianco caldo (opz.7401), rosa quarzo (opz.8171), blu cadetto (opz.8373),



TH. 22 MM

OLTRE Bridge

Note: the prices are expressed in units of Euro (vat not included)

TECHNICAL FEATURES**DOORS AND
DRAWER FRONTS**

22 mm th. MDF door, with **soft textured matt lacquered finish in the following cold colours**: absolute white (opt.740S), ash (opt.9547), clay (opt.9503), bromine grey (opt.9533), black (opt.7892), midnight blue (opt.8375), cornflower blue (opt.8377)

22 mm th. MDF door, with **soft textured matt lacquered finish in the following warm colours**: warm white (opt.7401), hemp (opt.8531), kenya grey (opt.9501), beaver (opt.8907), smoke (opt.9531), lead grey (opt.9537), bistro (opt.9535), lichen green (opt.8463), positano green (opt.8471), amber yellow (opt.327S), tuscan red (opt.8157), siena earth (opt.8161)

HANDLES

standard: 574 brown oxidized steel finish, 16/160/320 centre-to-centre distance depending to the door measure

on request: 491 stainless steel satin finish, 96/160/320 centre-to-centre distance depending to the door measure
 475M matt brown finish, 96/160/320 centre-to-centre distance depending to the door measure
 477 chrome finish, 64/160/320 centre-to-centre distance depending to the door measure
 551 chrome finish, 64/160/320 centre-to-centre distance depending to the door measure
 590 hammered black finish, 96/192 centre-to-centre distance depending to the door measure
 578D old dark finish, 64/192/320 centre-to-centre distance depending to the door measure
 578G old grey finish, 64/192/320 centre-to-centre distance depending to the door measure
 585 half-matt oxidized steel finish, 64/160 centre-to-centre distance depending to the door measure
 576 urban finish, 96/160/320 centre-to-centre distance depending to the door measure
 575 iron finish, 64/192/320 centre-to-centre distance depending to the door measure
 581 built-in bronze titanium finish, 64/128 centre-to-centre distance
 M40 soft black finish, centre-to-centre distance depending to the door measure
 M41 unrefined iron finish, centre-to-centre distance depending to the door measure
 M42 nickel satin finish, centre-to-centre distance depending to the door measure
 M40V soft black finish, centre-to-centre distance depending to the door measure
 M41V unrefined iron finish, centre-to-centre distance depending to the door measure
 M42V nickel satin finish, centre-to-centre distance depending to the door measure
 FU11 "fusion" matt black finish, centre-to-centre distance depending to the door measure
 FU12 "fusion" titanium finish, centre-to-centre distance depending to the door measure
 H51 urban finish, applied on top lenght depending on door
 H52 titanium finish, applied on top lenght depending on door

STRUCTURES

standard: melamine-coated white (opt.001), white back panel and shelf (opt.001)

on request: melamine-coated mink (opt.948M), mink back panel and shelf (opt.948M)
 melamine-coated slate grey (opt.9620), slate grey back panel and shelf (opt.9620)
 melamine-coated devalè with grafis finish (opt.796), white back panel and shelf (opt.001)
 melamine-coated oriental pearl (opt.940), white back panel and shelf (opt.001)
 melamine-coated mud (opt.8860), mud back panel and shelf (opt.8860)

SHELVES

standard: : height 3.8 cm, in laminate to match structure: white (opt.001) oriental pearl (opt.940) devalè grafis (opt.796), mink (opt.948M), slate grey (opt.9620), mud (opt.8860)

on request: height 3.8 cm, matt lacquered same finish as doors

PLINTHS

standard: plinth H 6 cm, in aluminium with oxidised titanium (opt.414) finish

on request: plinth H 6 cm in aluminium with oxidised urban (opt.NU), brill (opt.412) finishes
 plinth H 6 cm in aluminium with matt powder coating in the following colours: black (opt.7892), amber yellow (opt.8225), sage (opt.8443), tuscan red (opt.8157), mist grey (opt.9551), absolute white (opt.740S), aquamarine (opt.8323), water green (opt.8473), positano green (opt.8471), beaver (opt.8907), lichen green (opt.8463), bromine grey (opt.9533), smoke (opt.9531), warm white (opt.7401), rose quartz (opt.8171), cadet blue (opt.8373),

TH. 22 MM

Note: the prices are expressed in units of Euro (vat not included)

TECHNICAL FEATURES**DOORS AND
DRAWER FRONTS**

22 mm th. MDF door, with **brushed glossy lacquered finish in the following cold colours**: absolute white (opt.741), ash (opt.9548), clay (opt.9504), bromine grey (opt.9534), black (opt.7893), midnight blue (opt.8376), cornflower blue (opt.8378)

22 mm th. MDF door, with **brushed glossy lacquered finish in the following warm colours**: warm white (opt.7402), hemp (opt.8532), kenya grey (opt.9502), beaver (opt.8908), smoke (opt.9532), lead grey (opt.9538), bistro (opt.9536), lichen green (opt.8464), positano green (opt.8472), amber yellow (opt.328), tuscan red (opt.8158), siena earth (opt.8162)

HANDLES

standard: 574 brown oxidized steel finish, 16/160/320 centre-to-centre distance depending to the door measure

on request: 491 stainless steel satin finish, 96/160/320 centre-to-centre distance depending to the door measure

475M matt brown finish, 96/160/320 centre-to-centre distance depending to the door measure

477 chrome finish, 64/160/320 centre-to-centre distance depending to the door measure

551 chrome finish, 64/160/320 centre-to-centre distance depending to the door measure

590 hammered black finish, 96/192 centre-to-centre distance depending to the door measure

578D old dark finish, 64/192/320 centre-to-centre distance depending to the door measure

578G old grey finish, 64/192/320 centre-to-centre distance depending to the door measure

585 half-matt oxidized steel finish, 64/160 centre-to-centre distance depending to the door measure

576 urban finish, 96/160/320 centre-to-centre distance depending to the door measure

575 iron finish, 64/192/320 centre-to-centre distance depending to the door measure

581 built-in bronze titanium finish, 64/128 centre-to-centre distance

M40 soft black finish, centre-to-centre distance depending to the door measure

M41 unrefined iron finish, centre-to-centre distance depending to the door measure

M42 nickel satin finish, centre-to-centre distance depending to the door measure

M40V soft black finish, centre-to-centre distance depending to the door measure

M41V unrefined iron finish, centre-to-centre distance depending to the door measure

M42V nickel satin finish, centre-to-centre distance depending to the door measure

FU11 "fusion" matt black finish, centre-to-centre distance depending to the door measure

FU12 "fusion" titanium finish, centre-to-centre distance depending to the door measure

H51 urban finish, applied on top length depending on door

H52 titanium finish, applied on top length depending on door

STRUCTURES

standard: melamine-coated white (opt.001), white back panel and shelf (opt.001)

on request: melamine-coated mink (opt.948M), mink back panel and shelf (opt.948M)

melamine-coated slate grey (opt.9620), slate grey back panel and shelf (opt.9620)

melamine-coated devalè with grafis finish (opt.796), white back panel and shelf (opt.001)

melamine-coated oriental pearl (opt.940), white back panel and shelf (opt.001)

melamine-coated mud (opt.8860), mud back panel and shelf (opt.8860)

SHELVES

standard: : height 3.8 cm, in laminate to match structure: white (opt.001) oriental pearl (opt.940) devalè grafis (opt.796), mink (opt.948M), slate grey (opt.9620), mud (opt.8860)

on request: height 3.8 cm, glossy lacquered same finish as doors

PLINTHS

standard: plinth H 6 cm, in aluminium with oxidised titanium (opt.414) finish

on request: plinth H 6 cm in aluminium with oxidised urban (opt.NU), brill (opt.412) finishes

plinth H 6 cm in aluminium with matt powder coating in the following colours: black (opt.7892), amber yellow (opt.8225),

sage (opt.8443), tuscan red (opt.8157), mist grey (opt.9551), absolute white (opt.740S),

aquamarine (opt.8323), water green (opt.8473), positano green (opt.8471),

beaver (opt.8907), lichen green (opt.8463), bromine grey (opt.9533), smoke (opt.9531),

warm white (opt.7401), rose quartz (opt.8171), cadet blue (opt.8373),

cod. **283**

Laccato Opaco

Matt Lacquered

SP. 22 MM TH. 22 MM

ante laccate opache
matt doors lacquered

OLTRE **B**ridge



anta argilla (opz.9503)
clay door (opt.9503)



frontale cestone argilla (opz.9503)
clay deep drawer (opt.9503)



cassetto argilla (opz.9503)
clay drawer (opt.9503)

COLORI FREDDI OPACHI SOFT SOFT MATT COLD COLOURS

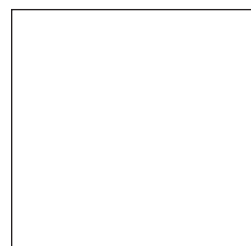

bianco assoluto (opz.740S)
absolute white

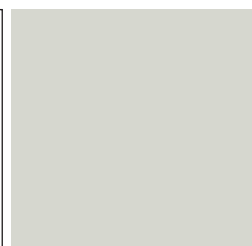

cenere (opz.9547)
ash

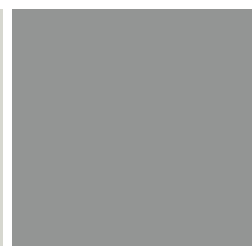

argilla (opz.9503)
clay

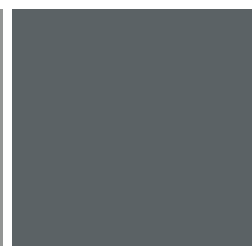

grigio bromo (opz.9533)
bromine grey

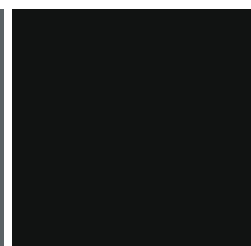

nero (opz.7892)
black

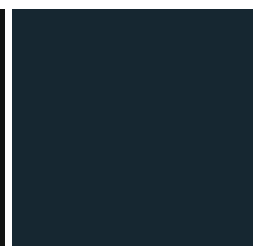

blu notte (opz.8375)
midnight blue

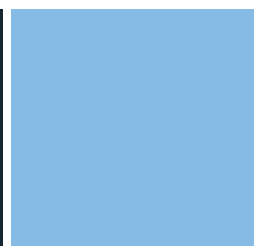

blu fiordaliso (opz.8377)
cornflower blue

COLORI CALDI OPACHI SOFT SOFT MATT HOT COLOURS



bianco caldo (opz.7401)
warm white

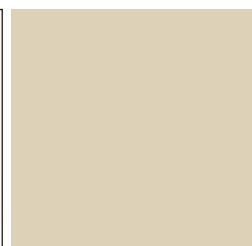

canapa (opz.8531)
hemp

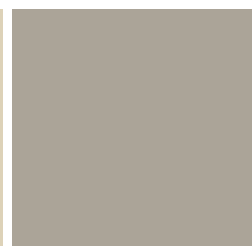

grigio kenya (opz.9501)
kenya grey

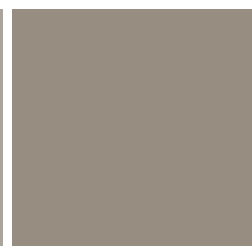

castoro (opz.8907)
beaver

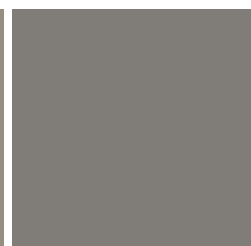

fumo (opz.9531)
smoke

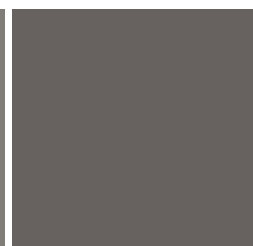

grigio piombo (opz.9537)
lead grey



bistro (opz.9535)
bistro



verde lichene (opz.8463)
lichen green



verde positano (opz.8471)
positano green



giallo ambra (opz.327S)
amber yellow

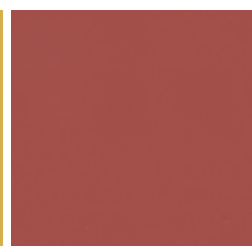

rosso toscano (opz.8157)
tuscan red

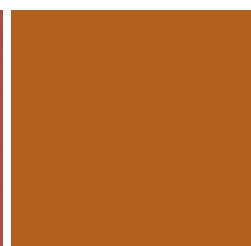

terra di siena (opz.8161)
siena earth



colore a campione Ral (opz.998)
RAL sample colours

CONSEGNA: MINIMO 5 SETTIMANE DALLA CONFERMA DELL' ORDINE
DELIVERY: MINIMUM 5 WEEKS FROM ORDER CONFIRMATION

cod. **284**

Laccato Lucido Spazzolato

Brushed Glossy Lacquered

SP. 22 MM TH. 22 MM

ante laccate lucide
glossy doors lacquered

OLTRE **B**ridge



anta grigio bromo (opz.9534)
bromine grey door (opt.9534)



frontale cestone grigio bromo
(opz.9534)
bromine grey deep drawer (opt.9534)



cassetto grigio bromo (opz.9534)
bromine grey drawer (opt.9534)

COLORI FREDDI SPAZZOLATI GLOSSY BRUSHED COLD COLOURS

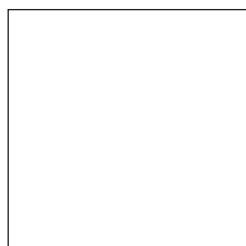

bianco assoluto (opz.741)
absolute white



cenere (opz.9548)
ash



argilla (opz.9504)
clay



grigio bromo (opz.9534)
bromine grey



nero (opz.7893)
black



blu notte (opz.8376)
midnight blue



blu fiordaliso (opz.8378)
cornflower blue

COLORI CALDI SPAZZOLATI GLOSSY BRUSHED HOT COLOURS



bianco caldo (opz.7402)
warm white



canapa (opz.8532)
hemp



grigio kenia (opz.9502)
kenya grey



castoro (opz.8908)
beaver



fumo (opz.9532)
smoke

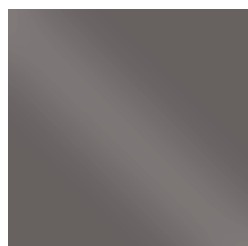

grigio piombo (opz.9538)
lead grey



bistro (opz.9536)
bistro



verde lichene (opz.8464)
lichen green



verde positano (opz.8472)
positano green



giallo ambra (opz.328)
amber yellow



rosso toscano (opz.8158)
tuscan red



terra di siena (opz.8162)
siena earth

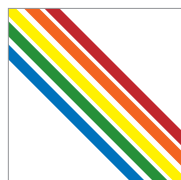

colore a campione Ral (opz.998)
RAL sample colours

CONSEGNA: MINIMO 5 SETTIMANE DALLA CONFERMA DELL' ORDINE
DELIVERY: MINIMUM 5 WEEKS FROM ORDER CONFIRMATION

SP. 22 MM**OLTRE** Bridge

N.B.: i prezzi sono espressi all'unità di euro (iva esclusa)

CARATTERISTICHE TECNICHE**ANTE E FRONTALI
CASSETTI**

anta sp.22 mm in mdf laccata **finitura semilucida effetto metallo vintage** nei colori:
peltro (opz.9549), ferro (opz.9506), urban (opz.7894), bronzo (opz.8904)

MANIGLIE

di serie: 574 finitura acciaio ossidato brown passo mm 16/160/320 in funzione dell'anta

a richiesta: 491 finitura inox satinato passo mm 96/160/320 in funzione dell'anta
475M finitura brown opaco passo mm 96/160/320 in funzione dell'anta
477 finitura cromo passo mm 64/160/320 in funzione dell'anta
551 finitura cromo passo mm 64/160/320 in funzione dell'anta
590 finitura nero martellato passo mm 96/192 in funzione dell'anta
578D finitura old dark passo mm 64/192/320 in funzione dell'anta
578G finitura old grey passo mm 64/192/320 in funzione dell'anta
585 finitura acciaio ossidato semiopaco passo mm 64/160 in funzione dell'anta
576 finitura urban passo mm 96/160/320 in funzione dell'anta
575 finitura ferro passo mm 64/192/320 in funzione dell'anta
581 incassata finitura bronzo titanio passo mm 64/128
M40 finitura nero soft passo in funzione dell'anta
M41 finitura ferro grezzo passo in funzione dell'anta
M42 finitura nichel satinato passo in funzione dell'anta
M40V finitura nero soft passo in funzione dell'anta
M41V finitura ferro grezzo passo in funzione dell'anta
M42V finitura nichel satinato passo in funzione dell'anta
FU11 "fusion" finitura nero opaco passo in funzione dell'anta
FU12 "fusion" finitura titanio passo in funzione dell'anta
H51 finitura urban applicata in testa lunghezza in funzione dell'anta
H52 finitura titanio applicata in testa lunghezza in funzione dell'anta

STRUTTURE

ANTE: peltro, ferro, urban

di serie: nobilitato lavagna (opz.9620) schiena e ripiano lavagna (opz.9620)

ANTA: bronzo

di serie: nobilitato fango (opz.8860) schiena e ripiano fango (opz.8860)

a richiesta: nobilitato visone (opz.948M) schiena e ripiano visone (opz.948M)
nobilitato bianco (opz.001) schiena e ripiano bianco (opz.001)
nobilitato devalè finitura grafis (opz.796) schiena e ripiano bianco (opz.001)
nobilitato perla d'oriente (opz.940) schiena e ripiano bianco (opz.001)

**MENSOLE**

di serie: altezza cm 3,8 in laminato come strutture: bianco (opz.001), perla d'oriente (opz.940), devalè grafis (opz.796), visone (opz.948M), lavagna (opz.9620), fango (opz.8860)

a richiesta: altezza cm 3,8 finiture come ante

ZOCCOLI

di serie: zoccolo H 6 in alluminio finitura titanio ossidato (opz.414)

a richiesta: zoccolo H 6 in alluminio finiture urban ossidato (opz.NU), brill (opz.412)

zoccolo H 6 in alluminio verniciato a polvere finitura opaca nei colori: nero (opz.7892), giallo ambra (opz.8225), salvia (opz.8443), rosso toscano (opz.8157), grigio nebbia (opz.9551), bianco assoluto (opz.740S), acquamarina (opz.8323), verde acqua (opz.8473), verde positano (opz.8471), castoro (opz.8907), verde lichene (opz.8463), grigio bromo (opz.9533), fumo (opz.9531), bianco caldo (opz.7401), rosa quarzo (opz.8171), blu cadetto (opz.8373),



Note: the prices are expressed in units of Euro (vat not included)

TECHNICAL FEATURES

DOORS AND DRAWER FRONTS

22 mm th. door in mdf with **vintage metal effect semi-gloss lacquer finish** in the following colours: pewter (opt. 9549), iron (opt. 9506), urban (opt. 7894), bronze (opt.8904)

HANDLES

standard: 574 brown oxidized steel finish, 16/160/320 centre-to-centre distance depending to the door measure

on request: 491 stainless steel satin finish, 96/160/320 centre-to-centre distance depending to the door measure
 475M matt brown finish, 96/160/320 centre-to-centre distance depending to the door measure
 477 chrome finish, 64/160/320 centre-to-centre distance depending to the door measure
 551 chrome finish, 64/160/320 centre-to-centre distance depending to the door measure
 590 hammered black finish, 96/192 centre-to-centre distance depending to the door measure
 578D old dark finish, 64/192/320 centre-to-centre distance depending to the door measure
 578G old grey finish, 64/192/320 centre-to-centre distance depending to the door measure
 585 half-matt oxidized steel finish, 64/160 centre-to-centre distance depending to the door measure
 576 urban finish, 96/160/320 centre-to-centre distance depending to the door measure
 575 iron finish, 64/192/320 centre-to-centre distance depending to the door measure
 581 built-in bronze titanium finish, 64/128 centre-to-centre distance
 M40 soft black finish, centre-to-centre distance depending to the door measure
 M41 unrefined iron finish, centre-to-centre distance depending to the door measure
 M42 nickel satin finish, centre-to-centre distance depending to the door measure
 M40V soft black finish, centre-to-centre distance depending to the door measure
 M41V unrefined iron finish, centre-to-centre distance depending to the door measure
 M42V nickel satin finish, centre-to-centre distance depending to the door measure
 FU11 "fusion" matt black finish, centre-to-centre distance depending to the door measure
 FU12 "fusion" titanium finish, centre-to-centre distance depending to the door measure
 H51 urban finish, applied on top lenght depending on door
 H52 titanium finish, applied on top lenght depending on door

STRUCTURES

DOORS: pewter, iron, urban
standard: melamine-coated slate grey (opt.9620), slate grey back panel and shelf (opt.9620)
DOOR: bronze
standard: melamine-coated mud (opt.8860), mud back back panel and shelf (opt.8860)

on request: melamine-coated mink (opt.948M), mink back panel and shelf (opt.948M)
 melamine-coated white (opt.001), white back panel and shelf (opt.001)
 melamine-coated devalè with grafis finish (opt.796), white back panel and shelf (opt.001)
 melamine-coated oriental pearl (opt.940), white back panel and shelf (opt.001)

SHELVES

standard: : height 3.8 cm, in laminate to match structure: white (opt. 001) oriental pearl (opt. 940) devalè grafis (opt. 796), mink (opt. 948M), slate grey (opt. 9620), mud (opt. 8860)

PLINTHS

on request: height 3.8 cm, finished to match doors

standard: plinth H 6 cm, in aluminium with oxidised titanium (opt.414) finish

on request: plinth H 6 cm in aluminium with oxidised urban (opt.NU), brill (opt.412) finishes
 plinth H 6 cm in aluminium with matt powder coating in the following colours: black (opt.7892), amber yellow (opt.8225), sage (opt.8443), tuscan red (opt.8157), mist grey (opt.9551), absolute white (opt.740S), aquamarine (opt.8323), water green (opt.8473), positano green (opt.8471), beaver (opt.8907), lichen green (opt.8463), bromine grey (opt.9533), smoke (opt.9531), warm white (opt.7401), rose quartz (opt.8171), cadet blue (opt.8373),

cod. **284**

Laccato Vintage Vintage Lacquered

SP. 22 MM TH. 22 MM

OLTRE **B**ridge

ante laccate vintage effetto metallo
lacquered vintage doors metal effect



anta peltro (opz.9549)
pewter door (opt.9549)



anta ferro (opz.9506)
iron door (opt.9506)



anta urban (opz.7894)
urban door (opt.7894)



anta bronzo (opz.8904)
bronze door (opt.8904)



BRIDGE

OLTRE **B**ridge Telaio alluminio

Aluminium frame

Vetro
Glass

abbinabile alle versioni: 280-281-282-283-284

matched with versions: 280-281-282-283-284

di serie: telaio alluminio sp.22 mm verniciato a polvere nero,
vetro temperato master line sp.4 mm (opz.NML)

standard: 22mm th. aluminium frame with black powder coating, 4mm th. master line tempered glass (opt.NML)



particolare telaio svasatura esterna
detail frame with external flared

SP. 22 MM TH. 22 MM

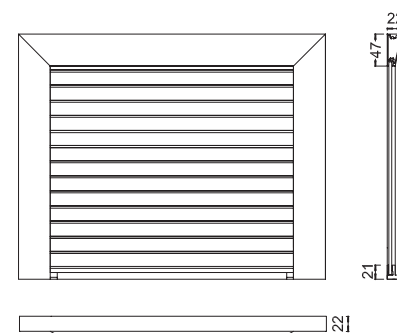

particolare maniglia
detail frame with handle

TELAIO
ALLUMINIO
ALUMINIUMFRAME

Vetro Lucido e Satinato

Glossy and Satin Glass

OLTRE^{BRIDGE}

abbinata a OLTRE Neck e Lux
model matched with OLTRE Neck and Lux

Nelle versioni OLTRE BRIDGE è possibile abbinare i vetri colorati delle versioni NECK e LUX

The colored glossy of versions NECK and LUX is possible to match in BRIDGE OLTRE versions

CARATTERISTICHE TECNICHE TECHNICAL FEATURES

Telaio alluminio sp.22 mm verniciato a polvere finitura opaca in tinta con il vetro, tamburato nella parte posteriore con pannello in HDF grigio cenere sp.3 mm.

Vetro temperato satinato sp.4 mm laccato nei colori caldi e freddi.

Vetro temperato lucido sp.4 mm laccato nei colori caldi e freddi.

Aluminium frame Th.22 mm dust painted with matt finish matching with the glass and back coated with an HDF panel colour ash grey.

Hardened satin glass, lacquered in the following hot and cold colours.

Hardened glossy glass, lacquered in the following hot and cold colours.

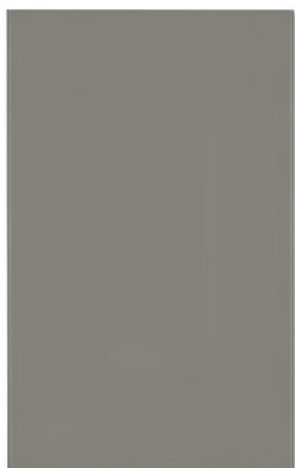

telaio alluminio, vetro fumo
aluminum frame, smoke glass



particolare retro anta grigio cenere
detail of the back side of the door,
ash grey colour

Neck

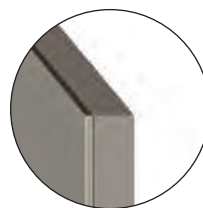

particolare anta squadrata
squared edge door detail

Lux

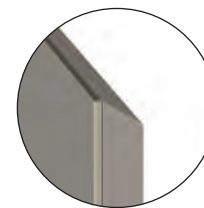

particolare anta inclinata
inclined edge door detail



SP. 22 MM TH. 22 MM

anta vetro satinato satin glass door

OLTRE Neck G55 LUX G65

COLORI FREDDI SATINATI SATIN COLD COLOURS

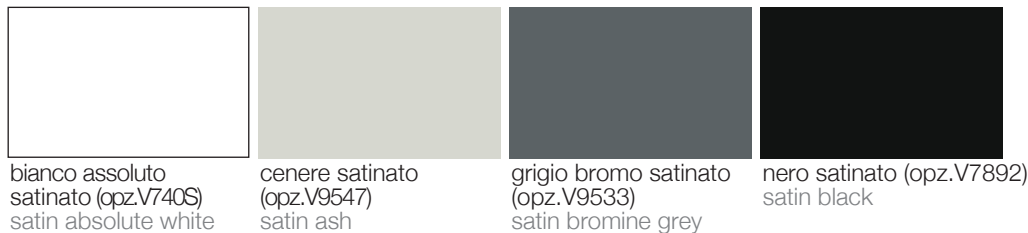

COLORI CALDI SATINATI SATIN HOT COLOURS

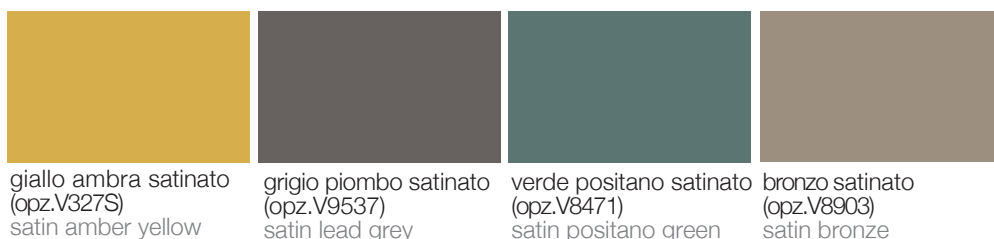

anta vetro lucido glossy glass doors

OLTRE Neck G56 LUX G66

COLORI FREDDI LUCIDO GLOSSY COLD COLOURS



COLORI CALDI LUCIDO GLOSSY HOT COLOURS



VETRO COLORATO COLOURED GLASS

MANIGLIE HANDLES

OLTRE **B**ridge

DI SERIE STANDARD



Maniglia 574 finitura acciaio ossidato brown
 anta L 15 → passo 16 mm
 anta da L 30 a L 60 → passo 160 mm
 anta da L 90 a L 120 → passo 320 mm

Handle 574 brown oxidized steel finish
 door W 15 → centre-to-centre distance 16 mm
 door from W 30 to W 60 → centre-to-centre distance 160 mm
 door from W 90 to W 120 → centre-to-centre distance 320 mm

A RICHIESTA ON REQUEST



Maniglia 590 finitura nero martellato
 anta L 15 → passo 96 mm
 anta da L 30 a L 120 → passo 192 mm

Handle 590 hammered black finish
 door W 15 → centre-to-centre distance 96 mm
 door from W 30 to W 120 → centre-to-centre distance 192 mm



Maniglia 475M finitura brown opaco
 anta L 15 → passo 96 mm
 anta da L 30 a L 45 → passo 160 mm
 anta da L 60 a L 120 → passo 320 mm

Handle 475M matt brown finish
 door W 15 → centre-to-centre distance 96 mm
 door from W 30 to W 45 → centre-to-centre distance 160 mm
 door from W 60 to W 120 → centre-to-centre distance 320 mm



Maniglia 575 finitura ferro
 anta L 15 → passo 64 mm
 anta da L 30 a L 45 → passo 192 mm
 anta da L 60 a L 120 → passo 320 mm

Handle 575 iron finish
 door W 15 → centre-to-centre distance 64 mm
 door from W 30 to W 45 → centre-to-centre distance 192 mm
 door from W 60 to W 120 → centre-to-centre distance 320 mm



Maniglia 576 finitura urban
 anta L 15 → passo 96 mm
 anta da L 30 a L 45 → passo 160 mm
 anta da L 60 a L 120 → passo 320 mm

Handle 576 urban finish
 door W 15 → centre-to-centre distance 96 mm
 door from W 30 to W 45 → centre-to-centre distance 160 mm
 door from W 60 to W 120 → centre-to-centre distance 320 mm



Maniglia 585 finitura acciaio ossidato semiopaco
 anta L 15 → passo 64 mm
 anta da L 30 a L 120 → passo 160 mm

Handle 585 half-matt oxidized steel finish
 door W 15 → centre-to-centre distance 64 mm
 door from W 30 to W 120 → centre-to-centre distance 160 mm



Maniglia 491 finitura inox satinato
 anta L 15 → passo 96 mm
 anta da L 30 a L 60 → passo 160 mm
 anta da L 90 a L 120 → passo 320 mm

Handle 491 stainless steel satin finish
 door W 15 → centre-to-centre distance 96 mm
 door from W 30 to W 60 → centre-to-centre distance 160 mm
 door from W 90 to W 120 → centre-to-centre distance 320 mm



Maniglia 578D finitura old dark
 anta L 15 → passo 64 mm
 anta da L 30 a L 45 → passo 192 mm
 anta da L 60 a L 120 → passo 320 mm

Handle 578D old dark finish
 door W 15 → centre-to-centre distance 64 mm
 door from W 30 to W 45 → centre-to-centre distance 192 mm
 door from W 60 to W 120 → centre-to-centre distance 320 mm



Maniglia 578G finitura old grey
 anta L 15 → passo 64 mm
 anta da L 30 a L 45 → passo 192 mm
 anta da L 60 a L 120 → passo 320 mm

Handle 578G old grey finish
 door W 15 → centre-to-centre distance 64 mm
 door from W 30 to W 45 → centre-to-centre distance 192 mm
 door from W 60 to W 120 → centre-to-centre distance 320 mm



Maniglia 477 finitura cromo
 anta L 15 → passo 64 mm
 anta da L 30 a L 45 → passo 160 mm
 anta da L 60 a L 120 → passo 320 mm

Handle 477 chrome finish
 door W 15 → centre-to-centre distance 64 mm
 door from W 30 to W 45 → centre-to-centre distance 160 mm
 door from W 60 to W 120 → centre-to-centre distance 320 mm



Maniglia 551 finitura cromo
 anta L 15 → passo 64 mm
 anta da L 30 a L 45 → passo 160 mm
 anta da L 60 a L 120 → passo 320 mm

Handle 551 chrome finish
 door W 15 → centre-to-centre distance 64 mm
 door from W 30 to W 45 → centre-to-centre distance 160 mm
 door from W 60 to W 120 → centre-to-centre distance 320 mm

strutture carcasses



bianco (opz.001)
schiena e ripiano bianco
(opz.001)
white (opt.001)
white back panel and shelf
(opt.001)



perla d'oriente (opz.940)
schiena e ripiano bianco
(opz.001)
oriental pearl (opt.940)
white back panel and shelf
(opt.001)



devalè finitura grafis
(opz.796) schiena e ripiano
bianco (opz.001)
devalè with grafis finish
(opt.796)
white back panel and shelf
(opt.001)



visone (opz.948M)
schiena e ripiano visone
(opz.948M)
mink (opt.948M)
mink back panel and shelf
(opt.948M)



lavagna (opz.9620)
schiena e ripiano lavagna
(opz.9620)
slate grey (opt.9620)
slate grey back panel
and shelf (opt.9620)



fango (opz.8860)
schiena e ripiano fango
(opz.8860)
mud (opt.8860)
mud back panel and shelf
(opt.8860)



LUBE ECOLOGIC

IL GRUPPO LUBE HA SCELTO DI UTILIZZARE PER I COMPONENTI COSTITUENTI LE STRUTTURE DELLE CUCINE SOLO MATERIALE A BASSISSIMA EMISSIONE DI FORMALDEIDE: CONFORMI ALLO STANDARD F**** SECONDO LA NORMA JIS, CERTIFICATO DAL MINISTERO GIAPPONESE, IL PIÙ SEVERO IN MERITO ALLE NORMATIVE DI SALVAGUARDIA AMBIENTALE.

LUBE GROUP HAS CHOSEN TO EXCLUSIVELY USE MATERIALS WITH VERY LOW FORMALDEHYDE EMISSIONS FOR THE COMPONENTS MAKING UP THE KITCHEN CARCASSES: THESE ELEMENTS COMPLY WITH THE F4 STAR STANDARD ACCORDING TO JIS, CERTIFIED BY THE JAPANESE GOVERNMENT - THE MOST STRINGENT WHEN IT COMES TO ENVIRONMENTAL PROTECTION.

mensole in laminato P 31-61 come strutture same colours as carcasses laminate shelves D 31-61



bianco (opz.001)
white (opt.001)



perla d'oriente (opz.940)
oriental pearl (opt.940)



devalè finitura grafis (opz.796)
devalè with grafis finish (opt.796)

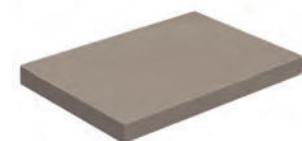

visone (opz.948M)
mink (opt.948M)

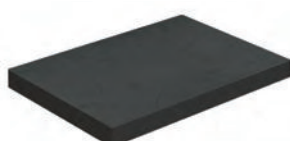

lavagna (opz.9620)
slate grey (opt.9620)

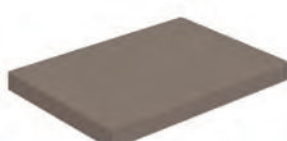

fango (opz.8860)
mud (opt.8860)

mensole impiallacciate veneered shelves



impiallacciata come anta
N.B.: per le finiture vedi pagine 202-203
veneered same finish as door
Note: for the finishes see pages 202-203

mensole fenix fenix shelves

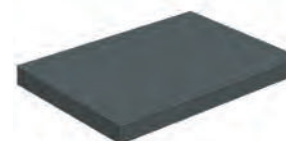

fenix come anta
N.B.: per le finiture vedi pagina 206
fenix as door
Note: for the finishes see page 206

mensole malta malta shelves



malta come anta
N.B.: per le finiture vedi pagina 210
malta as door
Note: for the finishes see page 210

mensole laccate lacquered shelves



laccate opache e lucide come anta
N.B.: per le finiture vedi pagine 216-217
matt and glossy lacquered as door
Note: for the finishes see pages 216-217

mensole laccate vintage vintage lacquered shelves



laccate vintage come anta
N.B.: per le finiture vedi pagina 220
vintage lacquered as door
Note: for the finishes see page 220

OLTRE **B**ridge

zoccoli in alluminio H 6 aluminium plinth H 6

di serie
standard



alluminio finitura titanio
ossidato (opz.414)
aluminium titanium
oxidized finish (opt.414)

zoccoli in alluminio H 6 aluminium plinth H 6

a richiesta
on request



alluminio finitura urban
ossidato (opz.NU)
aluminium urban
oxidized finish (opt.NU)

alluminio
finitura brill (opz.412)
aluminium
brill finish (opt.412)

zoccoli in alluminio H 6 verniciati a polvere finitura opaca
aluminum plinth height H 6 powder coated matt finish



alluminio finitura nero
(opz.7892)
aluminium
black finish (opt.7892)

alluminio finitura fumo
(opz.9531)
aluminium
smoke finish (opt.9531)

alluminio finitura
bianco caldo (opz.7401)
aluminium warm white
finish (opt.7401)

alluminio finitura
bianco assoluto (opz.740S)
aluminium absolute
white finish (opt.740S)

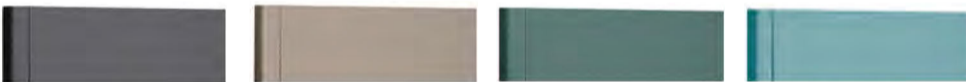

alluminio finitura
grigio bromo (opz.9533)
aluminium bromine
grey (opt.9533)

alluminio finitura
castoro (opz.8907)
aluminium beaver
(opt.8907)

alluminio finitura
verde positano
(opz.8471)
aluminium positano
green finish (opt.8471)

alluminio finitura
acquamarina
(opz.8323)
aluminium
aquamarine finish
(opt.8323)



alluminio finitura giallo
ambra (opz.8225)
aluminium amber
yellow finish (opt.8225)

alluminio finitura salvia
(opz.8443)
aluminium sage
finish (opt.8443)

alluminio finitura rosa
quarzo (opz.8171)
aluminium quartz
pink finish (opt.8171)

alluminio finitura rosso
toscano (opz.8157)
aluminium tuscan red
finish (opt.8157)



alluminio finitura grigio
nebbia (opz.9551)
aluminium fog grey
finish (opt.9551)

alluminio blu cadetto
(opz.8373)
aluminium cadet blue
finish (opt.8373)

alluminio finitura verde
lichene (opz.8463)
aluminium lichen green
finish (opt.8463)

alluminio finitura
verde acqua (opz.8473)
aluminium water green
finish (opt.8473)

top H 4 consigliati in laminato bordo ABS 1 recommended laminate worktops H 4 with ABS 1 edge



top H 4 consigliati in laminato Fenix recommended laminate worktops H 4 with Fenix



top H 4 consigliati in laminato Unicolor recommended laminate worktops H 4 with Unicolor





