

# SOVET

ITALIA



# Totem

collection booklet

# collection booklet

## Totem

Design **Studio Sovet**

“  
A lacquered metal base meets a top in glass, wood, ceramic or *Materia*, to give life to a tables collection with a distinctive personality and versatility in the setting, from home to contract spaces.

Una base in metallo laccato incontra un piano in cristallo, legno, ceramica o *Materia*, per dare forma a una famiglia di tavoli e tavolini tanto ricchi di personalità, quanto versatili nell'ambientazione: dagli ambienti domestici, agli spazi contract.

”

## Models & Dimensions

Dining table with lacquered metal base, various finishes. Tempered or laminated top in different measures, materials and finishes.

Tavolo con base in metallo laccato, varie finiture. Top temperato o stratificato in varie misure, materiali e finiture.

### round

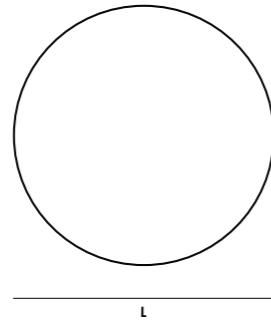
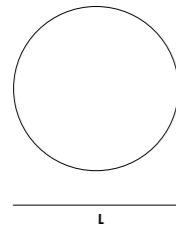
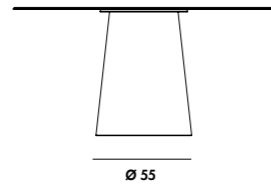
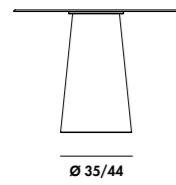

- Ø62x75h
- Ø80x75h
- Ø100x75h
- Ø110x75h
- Ø120x75h
- Ø130x75h
- Ø140x75h
- Ø150x75h
- Ø170x75h

### elliptical

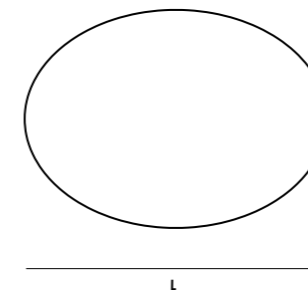
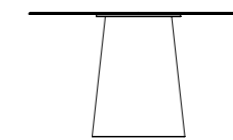
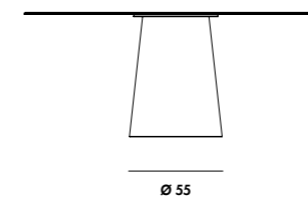

- 180x130x75h
- 200x110x75h
- 220x130x75h

## shaped

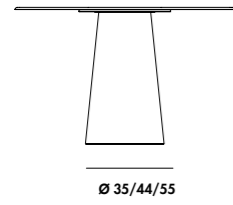

62x62x75h  
 80x80x75h  
 100x100x75h  
 120x120x75h  
 130x130x75h  
 140x140x75h  
 150x150x75h

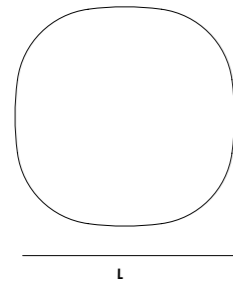

## bar

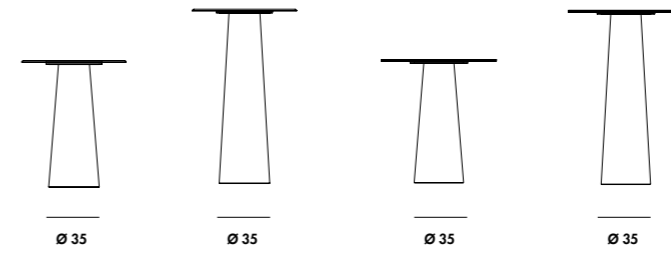

Ø62x75h  
 Ø80x75h  
 Ø62x110h  
 70x70x75h  
 70x70x110h

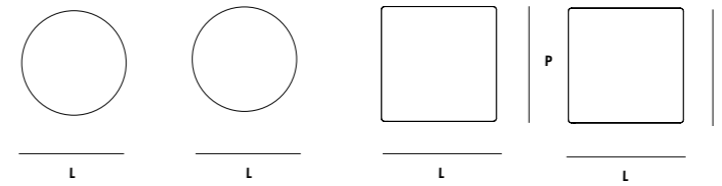

## shaped two bases

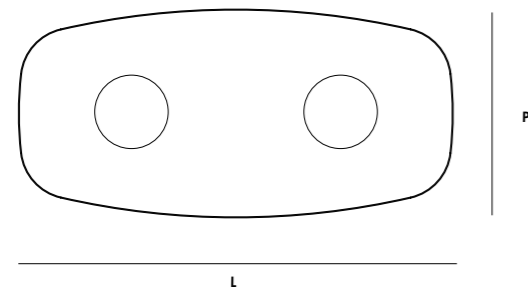
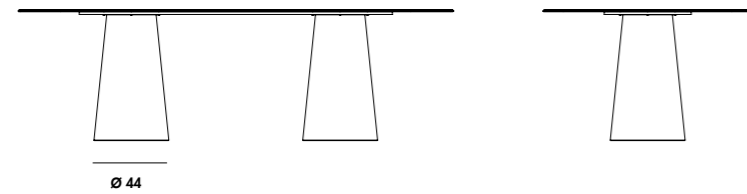

220x115x75h  
 250x120x75h  
 300x135x75h

## extensible

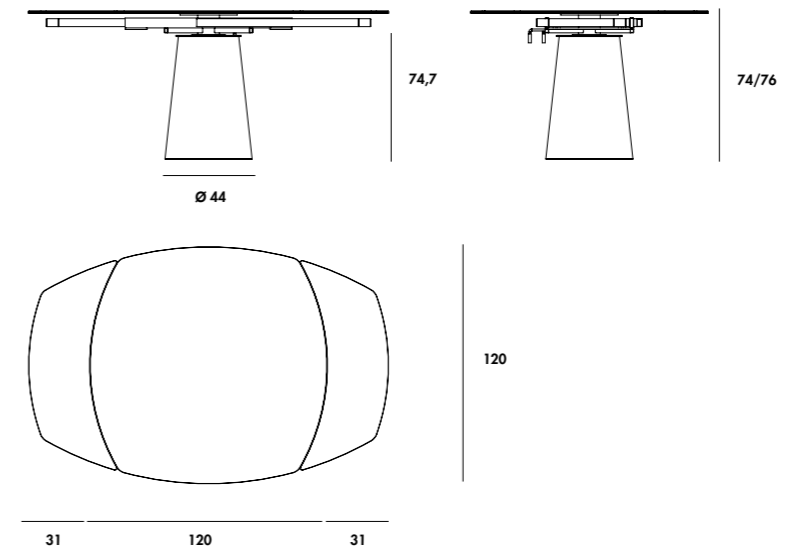

open  
 120x120x74/76h

close  
 182x120x74/76h

collection  
finishes



# TOP

## Vetro Glass Cat. B



**TEB1**  
Vetro extrachiaro laccato bianco latte  
Extralight glass lacquered milky white

**TEC1**  
Vetro extrachiaro laccato caffè  
Extralight glass lacquered mocha

**TEC2**  
Vetro extrachiaro laccato creta  
Extralight glass lacquered clay

**TEC3**  
Vetro extrachiaro laccato col. cemento  
Extralight glass lacquered cement

**TER4**  
Vetro extrachiaro laccato col. ruggine  
Extralight glass lacquered rust

**TEV2**  
Vetro extrachiaro laccato col. muschio  
Extralight glass lacquered moss green

## Vetro Glass Cat. D



**TEN1**  
Vetro extrachiaro laccato nero  
Extralight glass lacquered black

**TEM6**  
Vetro extrachiaro laccato col. tabacco  
Extralight glass lacquered tobacco

**TES1**  
Vetro extrachiaro laccato champagne  
Extralight glass lacquered champagne

## Vetro acidato Frosted glass Cat. E



**AEB1**  
Vetro acidato bianco  
Frosted white glass

**AEC2**  
Vetro acidato creta  
Frosted clay glass

**AEC3**  
Vetro acidato col. cemento  
Frosted cement glass

**AES1**  
Vetro acidato champagne  
Frosted champagne glass

## Net Glass

Cat. N

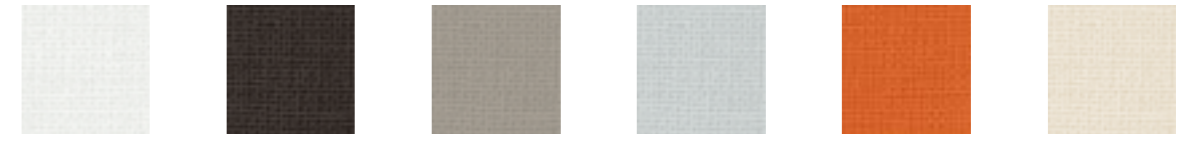

**NEB1**  
Net glass bianco  
White Net glass

**NEC1**  
Net glass caffè  
Mocha Net glass

**NEC2**  
Net glass creta  
Clay Net glass

**NEC3**  
Net glass col. cemento  
Cement Net glass

**NER4**  
Net glass col. ruggine  
Rust Net glass

**NES1**  
Net glass champagne  
Champagne Net glass



**NEV2**  
Net glass col. muschio  
Moss green Net glass

**NEN1**  
Net glass nero  
Black Net glass

**NEM6**  
Net glass col. tabacco  
Tobacco Net glass

## Liquid glass/ Materia

Cat. SC

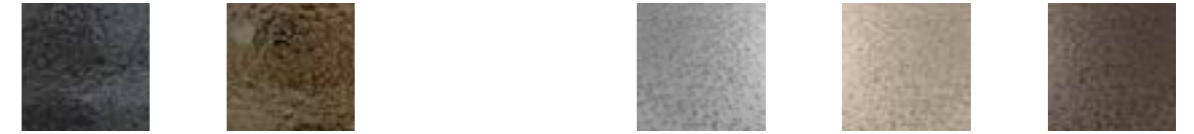

**LFSP**  
Liquid Glass fumè specchio  
Smoked liquid glass mirrored

**LBSP**  
Liquid Glass bronzo specchio  
Bronzed liquid glass mirrored

**MESP**  
Materia extrachiaro specchio  
Extralight mirror materia

**MES1**  
Materia extrachiaro champagne  
Extralight champagne materia

**MBSP**  
Materia bronzo specchio  
Mirrored bronzed materia

## Legni Woods



**NC**  
Noce canaletto  
Canaletto walnut

**RN**  
Rovere naturale  
Natural oak wood

**RG**  
Rovere tinto grigio  
Grey-stained oak

**WG**  
Rovere tinto wengè  
Wengè-stained oak

## HPL



**HB**  
Bianco bordo nero  
White black edge

**HN**  
Nero  
Black

**Ceramica**  
Ceramic  
Categoria CE1

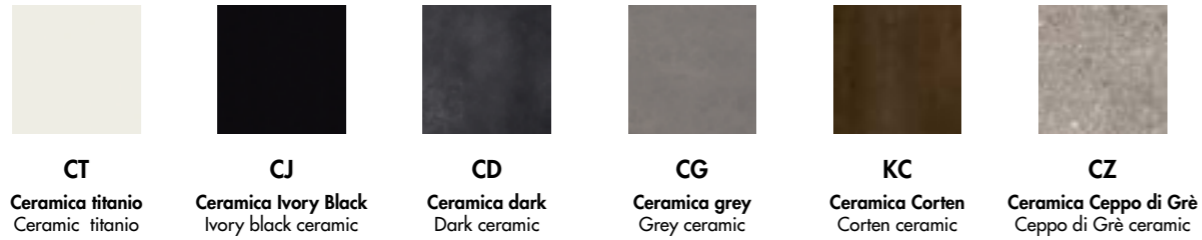

**CT**  
Ceramica titanio  
Ceramic titanio

**CJ**  
Ceramica Ivory Black  
Ivory black ceramic

**CD**  
Ceramica dark  
Dark ceramic

**CG**  
Ceramica grey  
Grey ceramic

**KC**  
Ceramica Corten  
Corten ceramic

**CZ**  
Ceramica Ceppo di Grè  
Ceppo di Grè ceramic



**CC**  
Ceramica Calacatta  
Prelucidata  
Pre-polished Calacatta  
ceramic

**CX**  
Ceramica Stone Grey  
Prelucidata  
Pre-polished Stone Grey  
ceramic

**KR**  
Ceramica breccia reale  
Breccia reale ceramic

**KB**  
Ceramica travertino  
stone beige  
Travertino stone beige  
ceramic

**Ceramica**  
Ceramic  
Categoria CE2

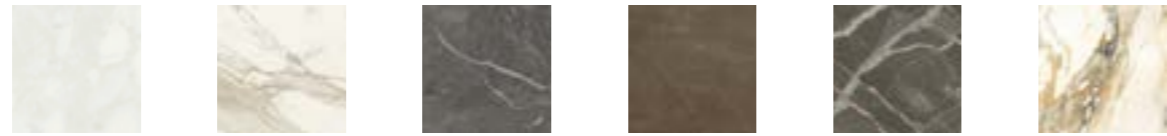

**CA**  
Ceramica Arabescato light  
Arabescato light  
ceramic

**CL**  
Ceramica Calacatta  
lucida  
Polished Calacatta  
ceramic

**CY**  
Ceramica Stone grey  
lucida  
Polished Stone grey  
ceramic

**CU**  
Ceramica Gaudi Stone  
Gaudi Stone  
ceramic

**CV**  
Ceramica Ombra di  
Caravaggio  
Ombra di Caravaggio  
ceramic

**CW**  
Ceramica Antique  
Antique ceramic



**CH**  
Ceramica Onice grigio  
Grey onyx ceramic

**CI**  
Ceramica Onice oro  
Gold Onyx ceramic

**KO**  
Ceramica Black Gold  
Black gold ceramic

**CQ**  
Ceramica Marquinia  
lucida  
Polished Marquinia  
ceramic

**KV**  
Ceramica Verde Aver  
Aver Green ceramic

**Dekton**

Categoria DE1

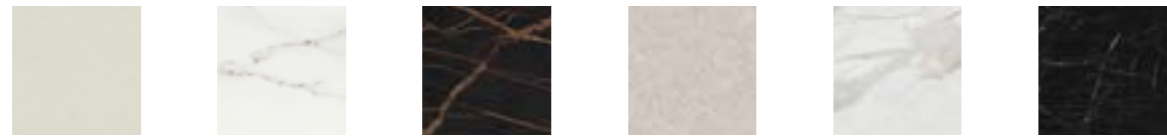

**D01**  
Aeris Dekton  
Dekton Aeris

**D02**  
Rem Dekton  
Dekton Rem

**D03**  
Laurent Dekton  
Dekton Laurent

**D04\***  
Nebbia Dekton  
Dekton Nebbia

**D05**  
Morpheus Dekton  
Dekton Morpheus

**D06**  
Somnia Dekton  
Dekton Somnia



**D07\***  
Umber Dekton  
Dekton Umber

**D08\***  
Sirius Dekton  
Dekton Sirius

\* Dekton D04 / D07 / D08 non disponibili in larghezza superiore a 140 cm.  
Dekton D04 / D07 / D08 not available in widths exceeding 140 cm.

# STRUCTURE

**Metalli**  
Metals



**GB**  
Bianco goffrato  
Embossed white

**GC**  
Caffè goffrato  
Embossed mocha

**GT**  
Creta goffrato  
Embossed clay

**GN**  
Nero goffrato  
Embossed black

**GS**  
Sabbia goffrato  
Embossed sand

		VETRO LACCATO LACQUERED GLASS	VETRO ACIDATO GLASS / FROSTED	NET GLASS	LIQUID GLASS/MATERIA	CERAMICA CERAMIC	LEGNO WOOD		
●	P1606	∅ 62x76h	10 BC	10 BC	12 FL	12 BC / 12 BC	15 FL 45°(6+8)	24 F 45°	15 FL 45°(8+6)
●	P1608	∅ 80x76h	10 BC	10 BC	12 FL	12 BC / 12 BC	15 FL 45°(6+8)	24 F 45°	15 FL 45°(8+6)
●	P1595	∅ 100x76h	12 FL 45°	12 FL 45°	12 FL	12 BC / 12 BC	15 FL 45°(6+8)		15 FL 45°(8+6)
●	P1549	∅ 110x76h	12 FL 45°	12 FL 45°	12 FL	12 BC / 12 BC	15 FL 45°(6+8)		15 FL 45°(8+6)
●	P1597	∅ 120x76h	12 FL 45°	12 FL 45°	12 FL	12 BC / 12 BC	15 FL 45°(6+8)		15 FL 45°(8+6)
●	P1598	∅ 130x76h	12 FL 45°	12 FL 45°	12 FL	12 BC / 12 BC	15 FL 45°(6+8)	24 F 45°	15 FL 45°(8+6)
●	P1605	∅ 140x76h	12 FL 45°	12 FL 45°	12 FL	12 BC / 12 BC	15 FL 45°(6+8)		15 FL 45°(8+6)
●	P1600	∅ 150x76h	12 FL 45°	12 FL 45°	12 FL	12 BC / 12 BC	15 FL 45°(6+8)	24 F 45°	15 FL 45°(8+6)
●	P1601	∅ 170x76h	12 FL 45°	12 FL 45°	12 FL				
●	P1606	∅ 62x75h	10 BC	10 BC	12 FL	12 BC / 12 BC	15 FL 45°(6+8)	24 F 45°	15 FL 45°(8+6)
●	P1608	∅ 80x75h	10 BC	10 BC	12 FL	12 BC / 12 BC	15 FL 45°(6+8)	24 F 45°	15 FL 45°(8+6)
●	P1614	∅ 62x110h	10 BC	10 BC	12 FL	12 BC / 12 BC	15 FL 45°(6+8)	24 F 45°	15 FL 45°(8+6)
■	P1707	70x70x75h	10 BC	10 BC	12 FL	12 BC / 12 BC	15 FL 45°(6+8)		15 FL 45°(8+6)
■	P1708	70x70x110h	10 FL	10 FL	12 FL	12 BC / 12 BC	15 FL 45°(6+8)		15 FL 45°(8+6)
■	P1607	62x62x75h	10 FL	10 FL	12 FL	12 BC / 12 BC	15 FL 45°(6+8)		15 FL 45°(8+6)
■	P1609	80x80x75h	10 BC	10 BC	12 FL	12 BC / 12 BC	15 FL 45°(6+8)		15 FL 45°(8+6)
■	P1596	100x100x75h	10 BC	10 BC	12 FL	12 BC / 12 BC	15 FL 45°(6+8)		15 FL 45°(8+6)
■	P1599	120x120x75h	10 BC	10 BC	12 FL	12 BC / 12 BC	15 FL 45°(6+8)		15 FL 45°(8+6)
■	P1697	130x130x75h	10 BC	10 BC	12 FL	12 BC / 12 BC	15 FL 45°(6+8)		15 FL 45°(8+6)
■	P1698	140x140x75h	10 BC	10 BC	12 FL	12 BC / 12 BC	15 FL 45°(6+8)		15 FL 45°(8+6)
■	P1699	150x150x75h	10 BC	10 BC	12 FL	12 BC / 12 BC	15 FL 45°(6+8)		15 FL 45°(8+6)
●	P1621	180x130x75h	10 BC	10 BC	12 FL	12 BC / 12 BC	15 FL 45°(6+8)		15 FL 45°(8+6)
●	P1602	200x110x75h	12 FL 45°	12 FL 45°	12 FL	12 BC / 12 BC	15 FL 45°(6+8)		15 FL 45°(8+6)
●	P1603	220x130x75h	12 FL 45°	12 FL 45°	12 FL	12 BC / 12 BC	15 FL 45°(6+8)		15 FL 45°(8+6)
●	P1604	220x115x75h	12 FL 45°	12 FL 45°	12 FL	12 BC / 12 BC	15 FL 45°(6+8)		15 FL 45°(8+6)
●	P1627	250x120x75h	12 FL 45°	12 FL 45°	12 FL	12 BC / 12 BC	15 FL 45°(6+8)		15 FL 45°(8+6)
●	P1628	300x135x75h	12 FL 45°	12 FL 45°	12 FL	12 BC / 12 BC	15 FL 45°(6+8)		15 FL 45°(8+6)
●	P1629	120x120x76h extensible	12 FL	12 FL	12 FL		13 FL 45°(6+6)		13 FL 45°(8+4)

**Vetro**

Le laccature utilizzate non presentano problemi di durata: basta evitare graffi e urti contro oggetti particolarmente duri e spigolosi. Il vetro è colorato solo sulla faccia posteriore sia nei vetri laccati coprenti mono e bicolore che nei vetri acidati laccati. La tonalità dei campioni proposti è indicativa e non va pertanto intesa in senso restrittivo; può infatti differire leggermente in conformità ai margini di tolleranza riconosciuti per i materiali impiegati. I materiali impiegati possono essere puliti tranquillamente solo con acqua oppure con un detergente neutro. Evitare l'uso di abrasivi, acidi o reagenti chimici. Il vetro è interpretato attraverso la sua trasparenza, pertanto la conformità al campione può differire a seconda della superficie e degli spessori impiegati. Un esempio lampante è dato dal vetro extrachiaro che nei campioncini si presenta completamente neutro ma che nei piani di dimensioni maggiori e con spessori più consistenti assume sfumature azzurro/verdi. Per tale ragione vi preghiamo anche di segnalare con particolare attenzione articoli che debbano essere affiancati o facenti parte di una stessa commissione.

La finitura bicolore consiste nella doppia laccatura nella parte interna della lastra di vetro. La prima laccatura, visibile attraverso la trasparenza del vetro, è disponibile nelle categorie B-D. La seconda laccatura, visibile internamente, equivale al colore pastello opaco utilizzato per ottenere le finiture di cat. B. Vi facciamo presente che in questo caso l'effetto finale differisce da quello creato dalla medesima laccatura attraverso il vetro, in particolare nei colori tenui.

**Specchi**

Gli specchi oro e rosa potrebbero presentare delle piccole imperfezioni dovute alle caratteristiche tecniche del materiale. Non possono essere utilizzati in luoghi umidi. Pulire solo con panni asciutti.

**Ceramica**

I campioni riportati sono una parte delle lastre che vengono lavorate. La lastra completa si può vedere nella corrispondente cartella. Pulire utilizzando acqua e una piccola quantità di detergente neutro. Evitare l'utilizzo di detersivi contenenti cere e prodotti ceranti per evitare la formazione di strati untuosi.

**Legno**

I colori dei legni sono campioni indicativi. Pulire utilizzando un panno morbido inumidito.

**Metalli**

I colori dei metalli sono campioni indicativi. Pulire utilizzando un panno morbido inumidito.

**Tessuti/Pelli/Ecopelli/Velluti**

I colori dei tessuti sono campioni indicativi. Per la cura e la manutenzione fare riferimento alle indicazioni riportate nelle rispettive cartelle e alle schede tecniche fornite dai produttori.

Se permangono dubbi contattare l'azienda.

**Glass**

The lacquering used for our furniture is extremely durable as long as you avoid scratching it or bumping particularly hard/sharp objects against it. The glass is lacquered only on the back side both for mono or two-tones lacquered and frosted lacquered glasses. The shade of the samples is only indicative and has not to be taken as restrictive. It can in fact slightly differ in conformity to the tolerances recognized for the materials used. All the materials we use can be easily cleaned with water only or with a mild detergent. Do not use abrasive materials, acids or harsh chemicals. The glass is interpreted through its transparency, therefore the conformity to the sample might differ according to the surface and the thickness used. For example, the extralight glass is completely neutral when seen in the small samples, but it takes a light blue/greenish shade when used on bigger or thicker tops. For this reason, we beg you to indicate carefully those articles which have to be placed side by side or which are part of the same commission.

The two-tones finish consists of a double lacquering on the internal part of the glass sheet. The first lacquering, which is visible through the transparency of the glass, is available in the finishes of cat. B-D. The second lacquering, which is visible internally, is the same of the mat pastel used to get the finishes of cat. B. Please notice that the final effect is different from the one created by the same lacquering through the glass, in particular when it comes to soft colours.

**Mirrors**

Gold and rose mirrors could have small imperfections due to the particular technical characteristics of the material. We recommend not to use them in damp areas. Clean only with a dry cloth.

**Ceramic**

The shown samples are part of the bigger slabs Sovet works with. The complete slab is visible in the corresponding folder. Clean using water and a small amount of neutral detergent. Avoid using detergents with wax and waxing products to avoid the formation of greasy layers.

**Wood**

Wood colours are indicative samples. Clean using a damp soft cloth.

**Metals**

Metals colours are indicative samples. Clean using a damp soft cloth.

**Fabrics/Leathers/Fake leathers/velvets**

Fabrics colours are indicative samples. For care and maintenance please refer to the instructions present in the corresponding folders and to the technical sheets provided by the manufacturers.

In case of further doubt please get in touch with the factory.

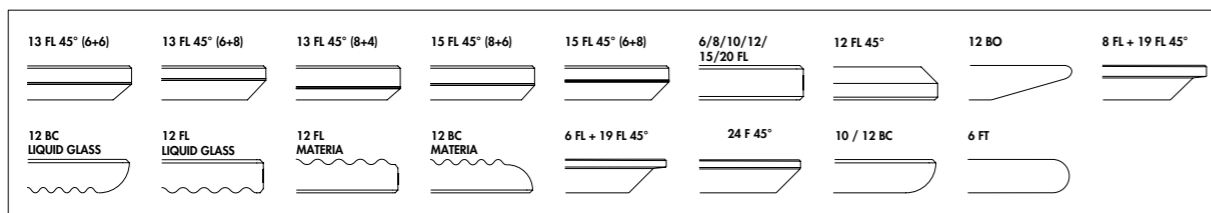



**Totem round** base GC top CV.  
**Autumn chairs** base DF seat P53 leather.



Totem round top RG.



Totem round base GC top RG.  
Pura chairs upholstered in Kvadrat Hallingdal 153.





Totem round base GN top RG.  
Cadira S wire chair base GN seat in Trevira Z09.





**Totem shaped two bases** base GN top CQ.  
**Sila chairs** base GN seat velvet Z09.  
**Traled lamp** ceramic CQ.



**Totem** elliptical base GT top TEV2.

In the next page **Totem** elliptical base GT top TEV2.

**Pura** chair upholstered in Kvadrat Hallingdal 103.







**Totem bar round and square base GT top HB.**  
**Sila chairs base GT seat in RN.**  
**Bell lamp.**



# designer

## Studio Sovet

**Studio Sovet is the development and design department of SO.VE.T. The team is composed of a group of figures that collaborate to create unique projects. For SOVETITALIA the good design raises in fact from the dialogue of ideas and concepts between people. The richness of this exchange leads to create unique products that resonate with their inner meanings of wisdom, craftsmanship and technology. These are the strengths of a company that has quality, design and service as a primary mission.**

Studio Sovet è il dipartimento di sviluppo e progettazione di SO.VE.T. Il team è composto da un insieme di figure che collaborano tra di loro per creare progetti unici. Per SOVETITALIA il buon design, infatti, nasce dal dialogo di idee e concetti tra le persone. La ricchezza di questo scambio porta a creare dei prodotti unici che richiamano al loro interno i significati di sapienza, artigianalità e tecnologia. Questi sono i punti di forza di un'azienda che fa della qualità, del design e del servizio al cliente una mission.

**SOVET**  
ITALIA

# sustainability is made up of facts.

Sovet has always maintained a high attention to eco-compatibility since its birth in 1987, through the selection of raw materials and the study of production processes that have the lowest impact on the environment with the aim of creating long-lasting products.

Sovet ha sempre mantenuto alta l'attenzione all'ecocompatibilità sin dalla sua nascita nel 1987, attraverso la selezione delle materie prime e lo studio di processi produttivi che abbiano il minimo impatto sull'ambiente con lo scopo di creare prodotti durevoli nel tempo.

## photovoltaic systems

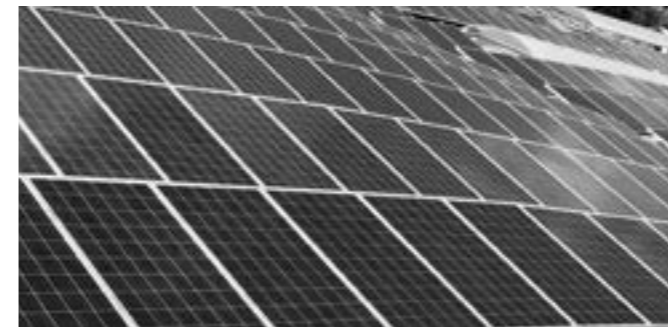

For its production processes, Sovet uses energy coming directly from renewable sources. Thanks to its photovoltaic systems, it is able to meet its own energy demand.

Per la sua produzione Sovet utilizza infatti energia derivante direttamente da fonti rinnovabili. Attraverso impianti fotovoltaici riesce a soddisfare il proprio fabbisogno energetico.



502695,549 kg emmissions saved per year



2989 trees saved per year



165 barrels of oil saved per year

## packaging



Sovet uses cardboard packaging with limited presence of oil-derivates.

Sovet usa imballi di cartone costruiti ad hoc con limitata presenza di derivati del petroli.



## reducing plastic is an habits



To reduce the consumption of plastic and disposable bottles within its offices and production, Sovet created metal water bottles.

Per ridurre il consumo di plastica e bottiglie monouso all'interno dei suoi uffici e della produzione, Sovet ha creato delle borracce in metallo.

# made in italy

**The creative use of industrial processes, the use of raw materials of highest quality and the scrupulous work of master craftsmen, allow Sovet to create high quality and 100% Made in Italy collections. Thanks to state-of-the-art industrial automation systems, Sovet is also able to meet also large supply needs for contract spaces, always granting the highest quality standards. The company takes a continuous search path for materials, to create an offer of accessories that complement one another, furnishing different kinds of environments with the maximum freedom when it comes to customization.**

L'impiego creativo dei processi industriali, l'utilizzo di materie prime di assoluta qualità e le scrupolose lavorazioni eseguite da maestranze artigiane, permettono a Sovet di ottenere collezioni di alta qualità e 100% Made in Italy. Grazie a sistemi di automazione industriale all'avanguardia Sovet è in grado di soddisfare anche esigenze per grandi forniture destinate a spazi contract, sempre garantendo i più elevati standard qualitativi. Sovet intraprende un percorso di ricerca dei materiali per creare un'offerta di complementi che si integrino tra di loro, arredando varie tipologie di ambienti con la massima possibilità di personalizzazione.

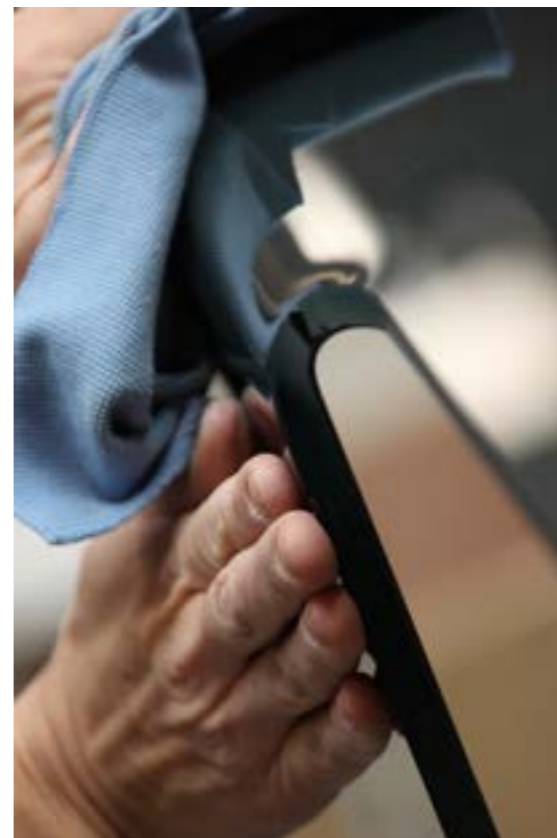



[sovet.com](https://www.sovet.com)